

SNAKE RIVER METAL



STANDARD TRIM LIST SPARTAN PANEL



SNAKE RIVER METAL



SPARTAN

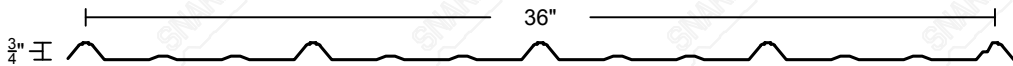

FASTENERS: EXPOSED

COVERAGE: 36"

MINIMUM PITCH: 2.5:12

MINIMUM LENGTH: 33"

MAXIMUM LENGTH: 40'

MATERIAL THICKNESS: 29G

FINISH: 40 YEAR SMP

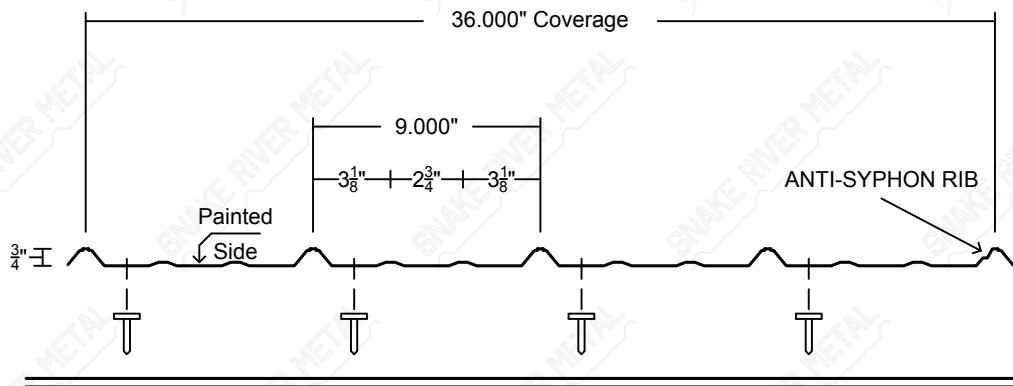
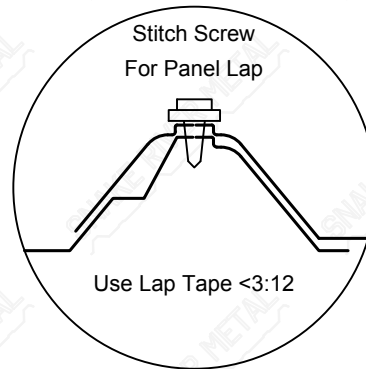

Common Building Geometries

(Click On Building That Best Matches Your Projects Geometry)

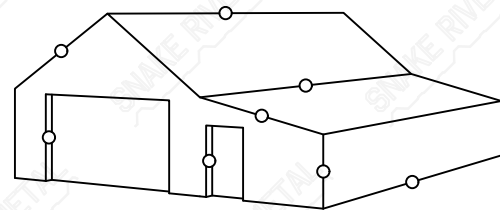
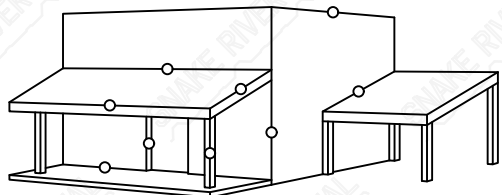
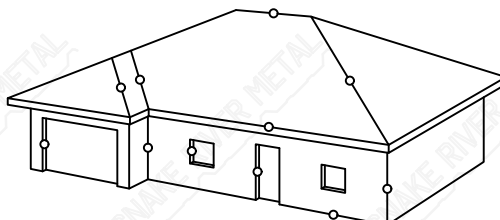
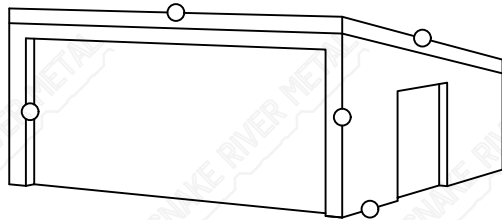
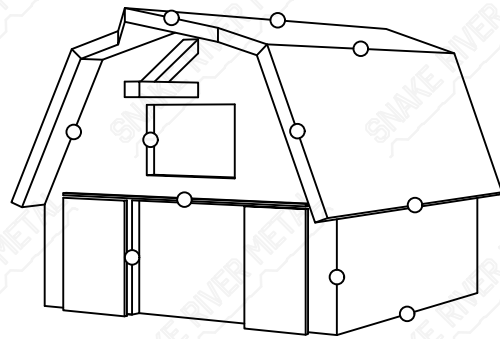
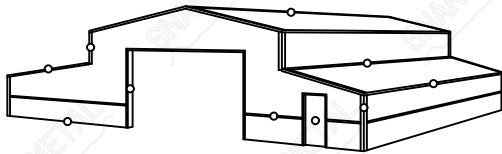
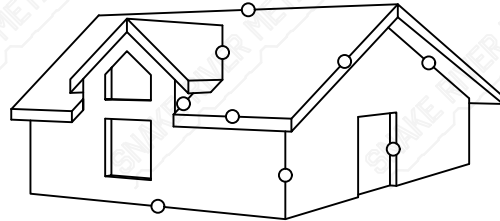
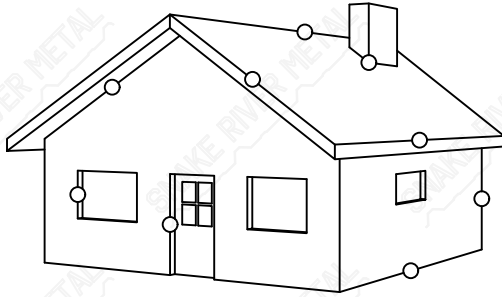

Gable Building Geometry On Next Page

Return
To Top

Gable Building Geometry

(Click On Circle That Best Matches Trim Location)

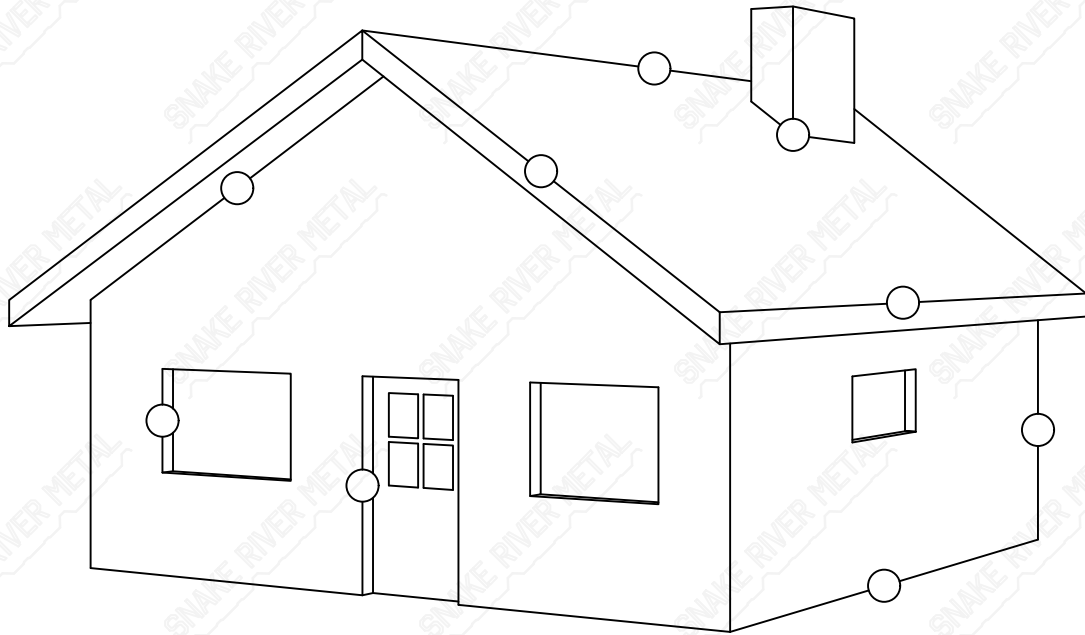

Dormer Building Geometry On Next Page

Return
To Top

Dormer Building Geometry

(Click On Circle That Best Matches Trim Location)

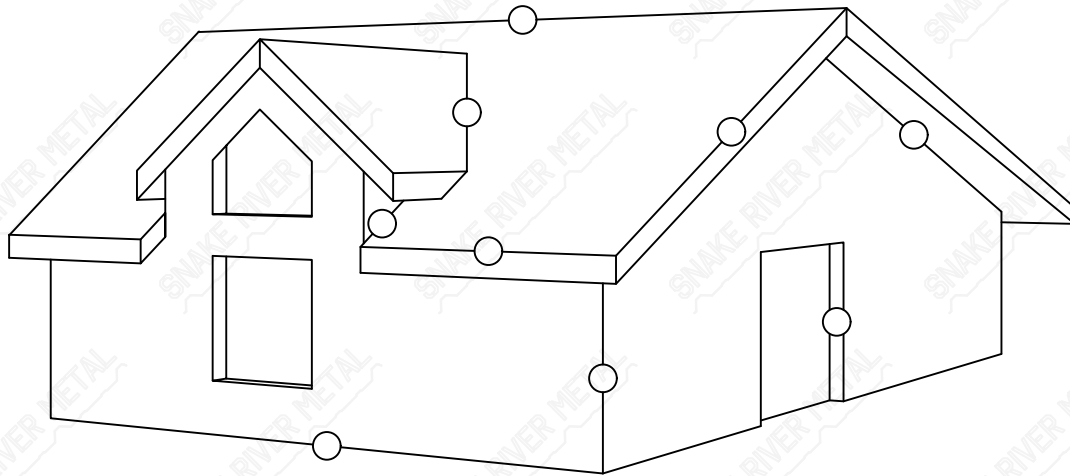

American Barn Geometry On Next Page

Return
To Top

American Barn Geometry

(Click On Circle That Best Matches Trim Location)

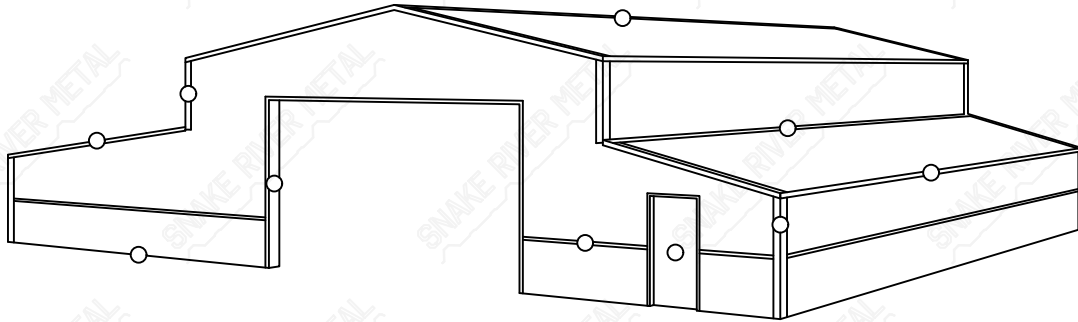

Gambrel Building Geometry On Next Page

Return
To Top

Gambrel Building Geometry

(Click On Circle That Best Matches Trim Location)

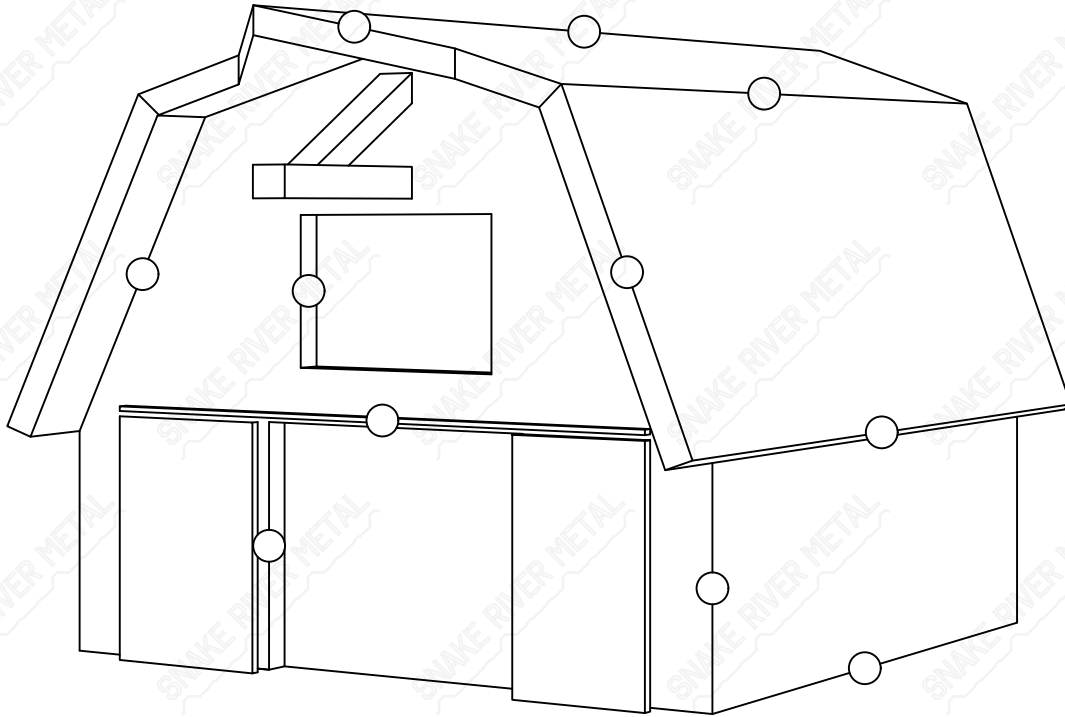

Single Slope Shed Geometry On Next Page

Return
To Top

Single Slope Shed Geometry

(Click On Circle That Best Matches Trim Location)

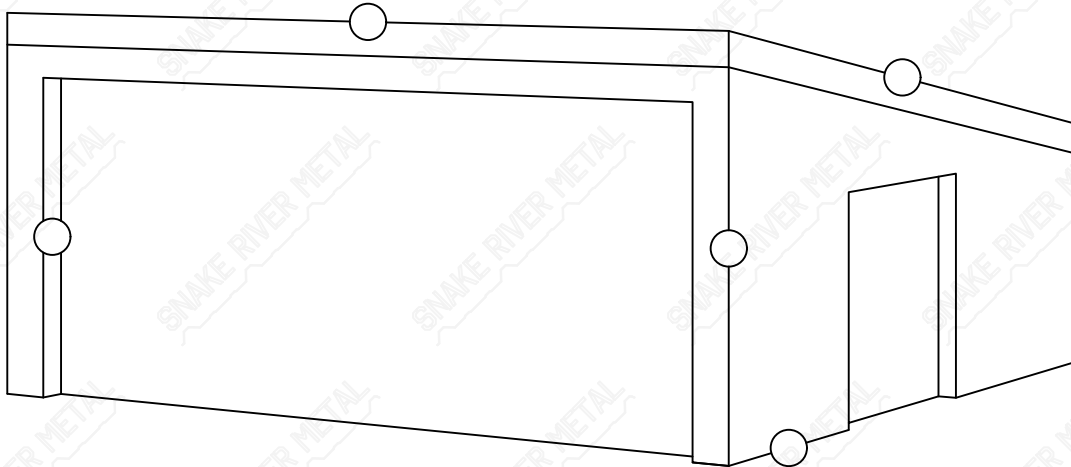

Hip Roof Geometry On Next Page

Return
To Top

Hip Roof Geometry

(Click On Circle That Best Matches Trim Location)

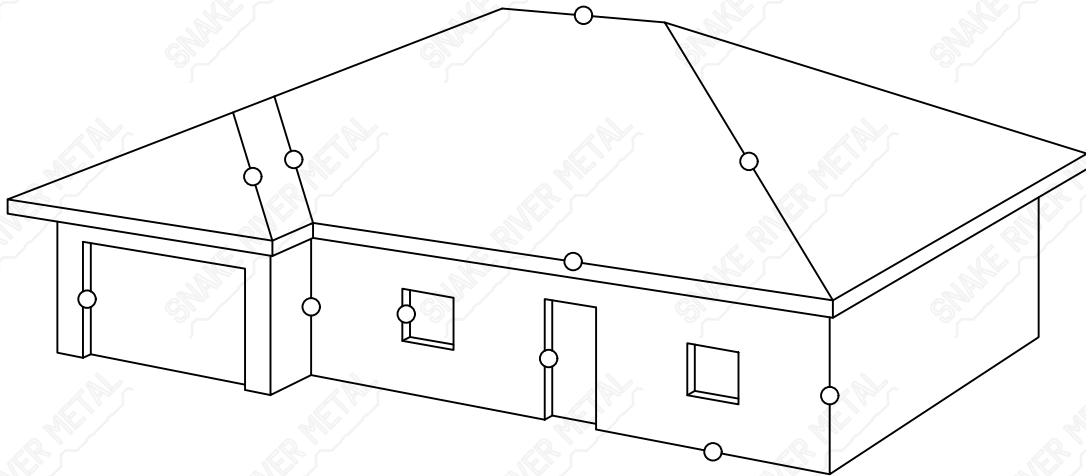

Leanto Building Geometry On Next Page

Return
To Top

Leanto Building Geometry

(Click On Circle That Best Matches Trim Location)

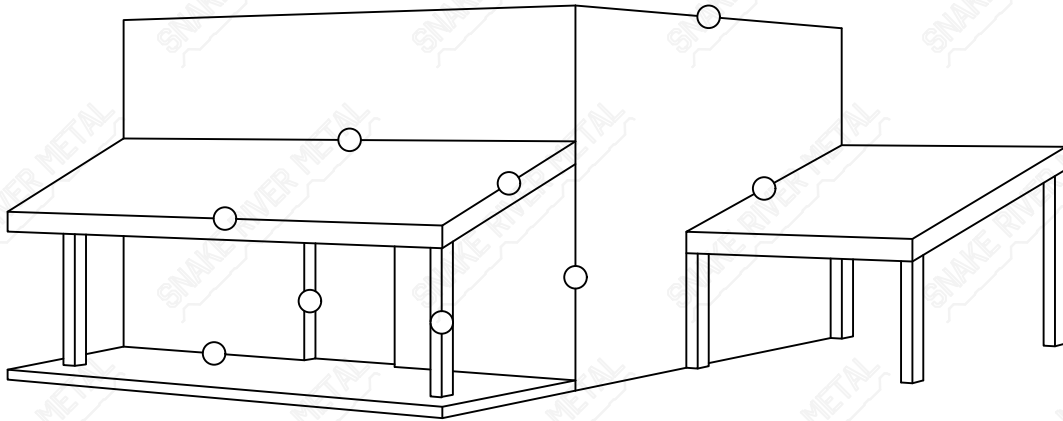

Transition Building Geometry On Next Page

Return
To Top

Transition Building Geometry

(Click On Circle That Best Matches Trim Location)

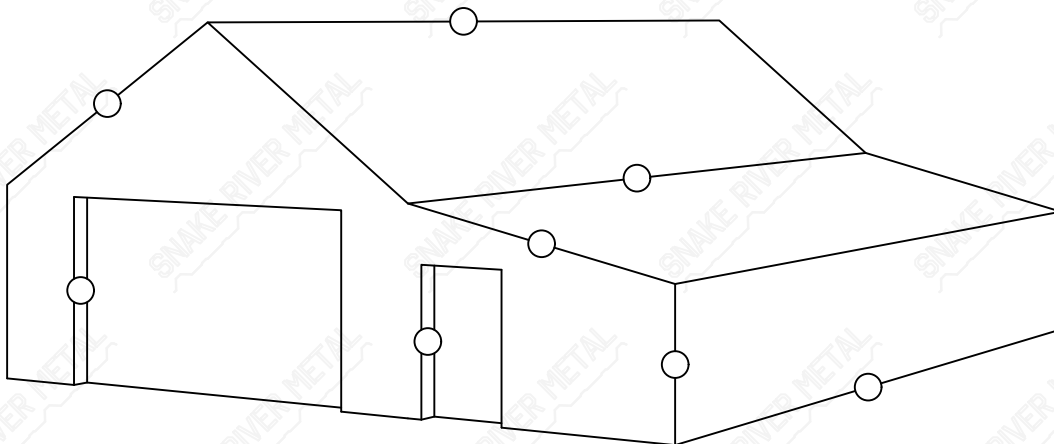

Ridge Cap On Next Page

Return
To Top

Ridge Cap - Spartan

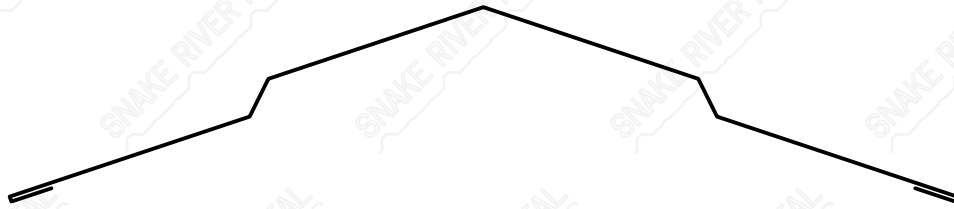

Ridge

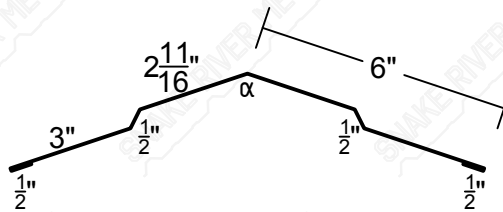

α : Specify Pitch Of Roof

For Vented Systems:
Cut Substrate And Panel

Back 1 1/2" To 2"

Insert
Vented / Solid
Closure

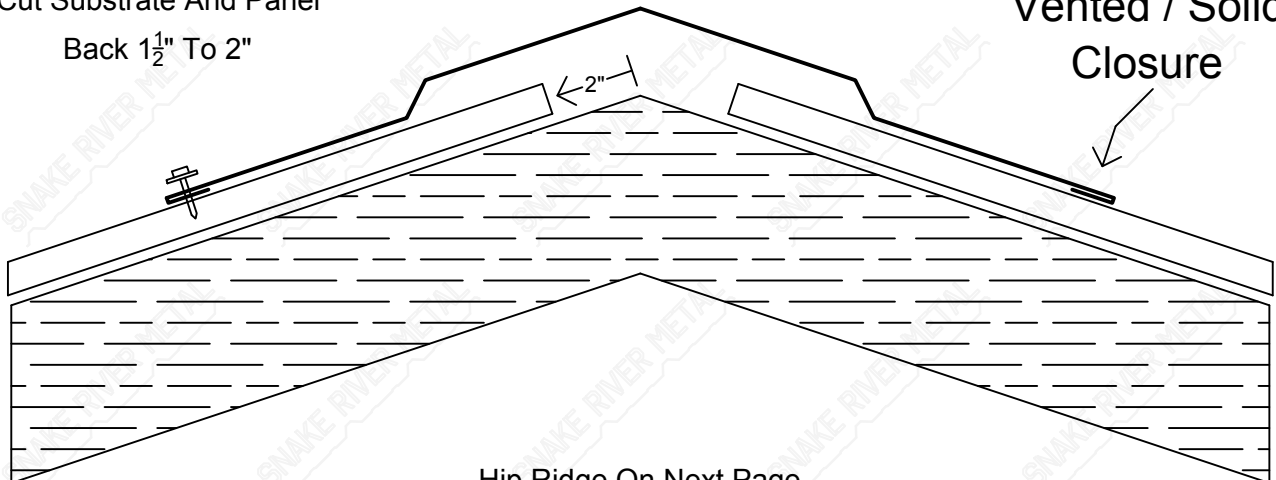

Hip Ridge On Next Page

Return
To Top

Hip Ridge - Spartan

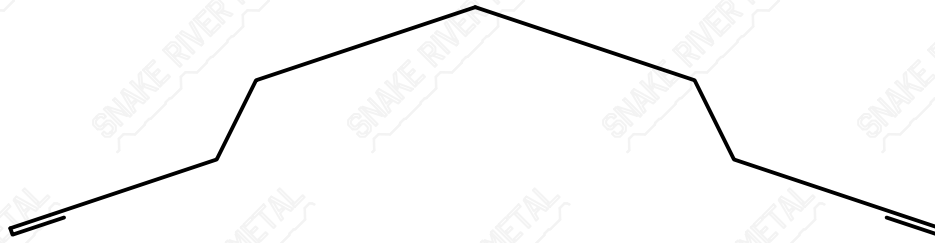

Hip Ridge

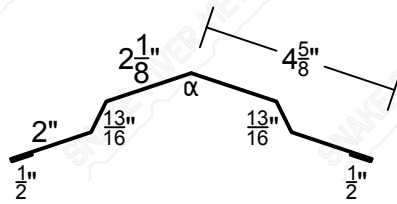

α: Specify Pitch Of Roof

For Vented Systems:
Cut Substrate And Panel
Back 1 1/2" To 2"

Insert
Vented / Solid
Closure

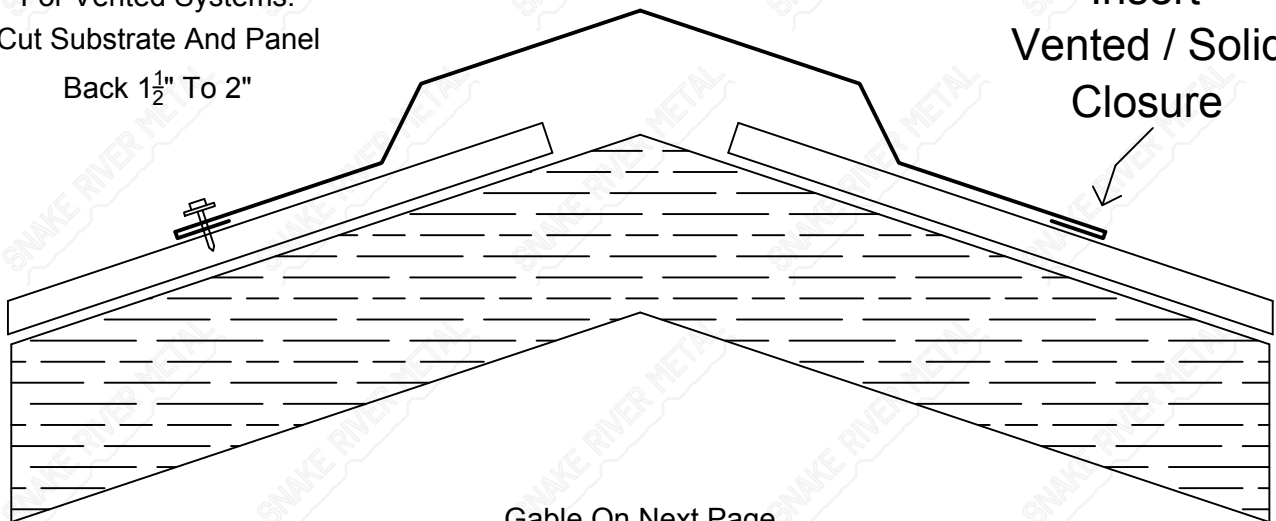

Gable On Next Page

Return
To Top

Gable - Spartan

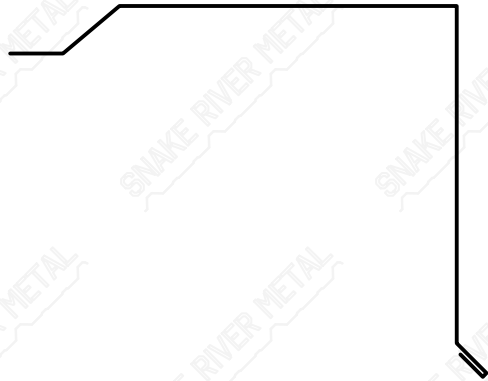

Gable

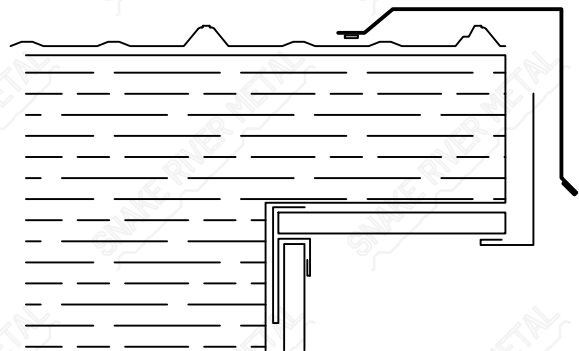
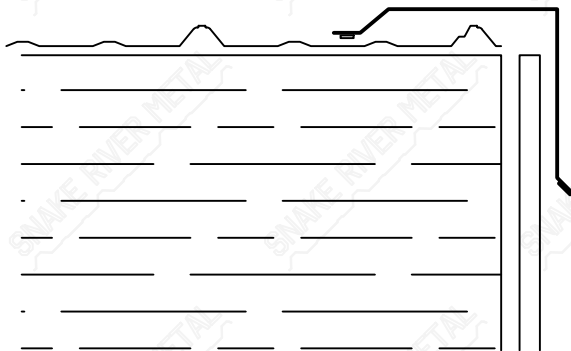
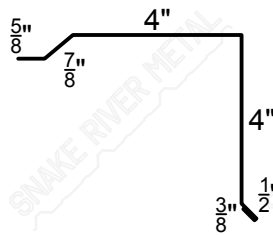

Mini Gable On Next Page

Return
To Top

Mini Gable - Spartan

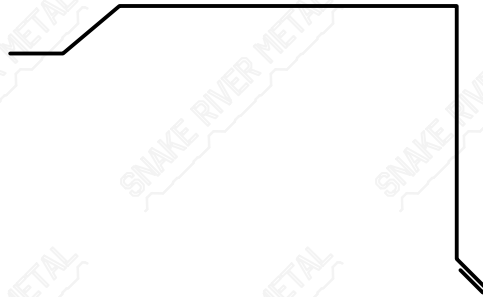

Mini Gable

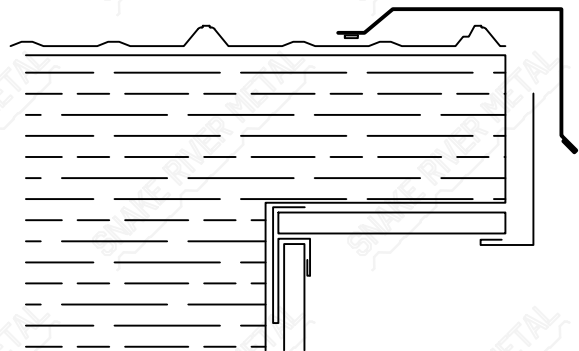
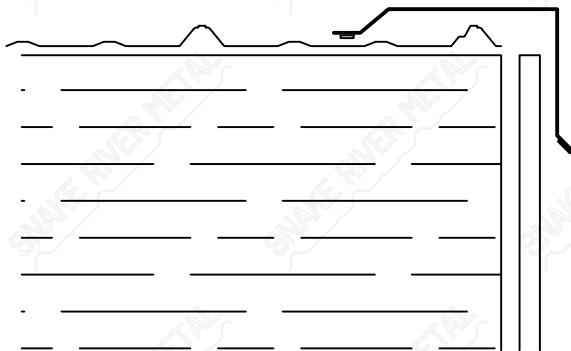
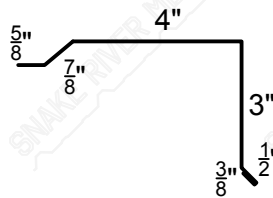

Modified Gable On Next Page

Return
To Top

Modified Gable - Spartan

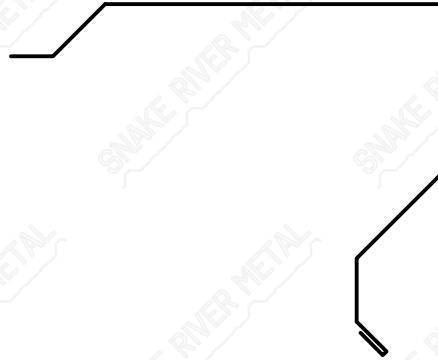

Modified Gable

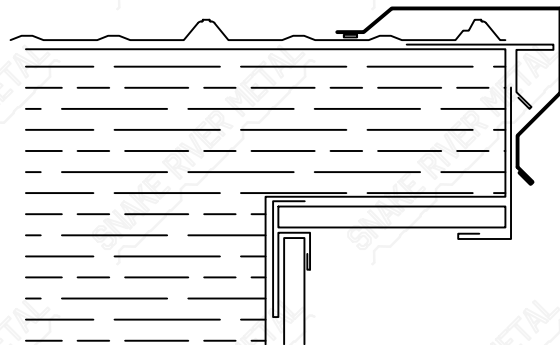
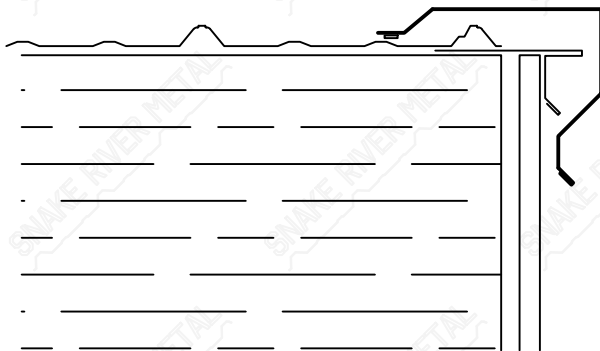
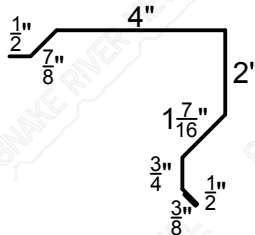

Swept Wing Gable On Next Page

Return
To Top

Swept Wing Gable - Spartan

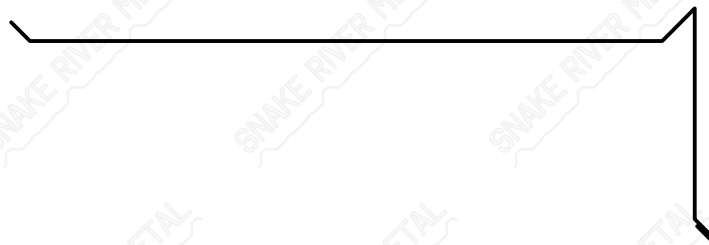

Swept Wing Gable

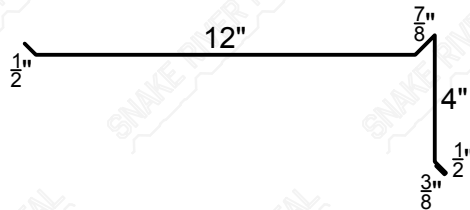

Laptape Sealant
Recommended

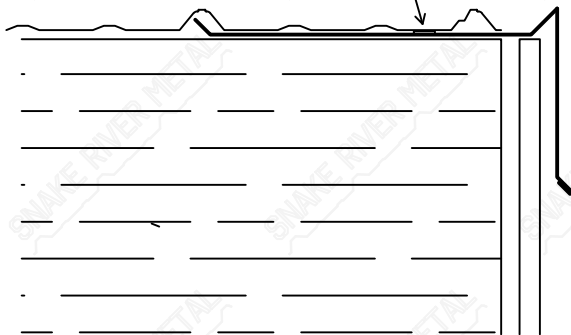

Laptape Sealant
Recommended

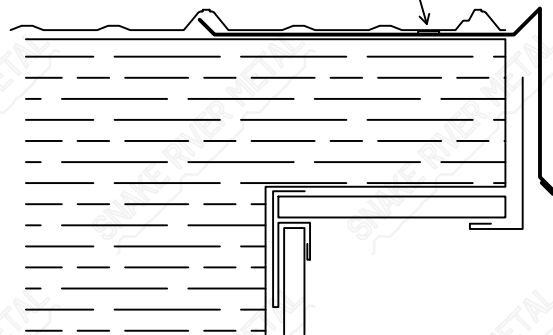

Fascia On Next Page

Return
To Top

Fascia - Spartan



Fascia (4" x 1 $\frac{1}{4}$ ")

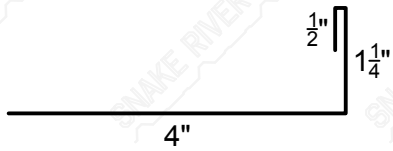

Fascia (6" x 1 $\frac{1}{4}$ ")

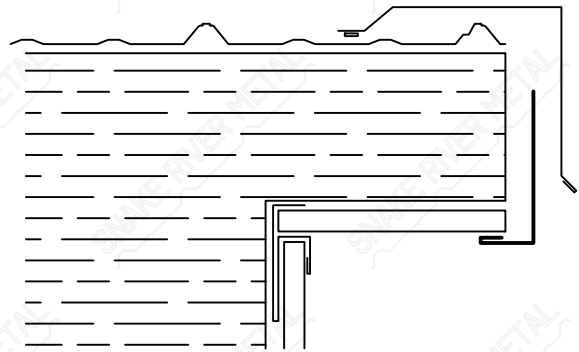
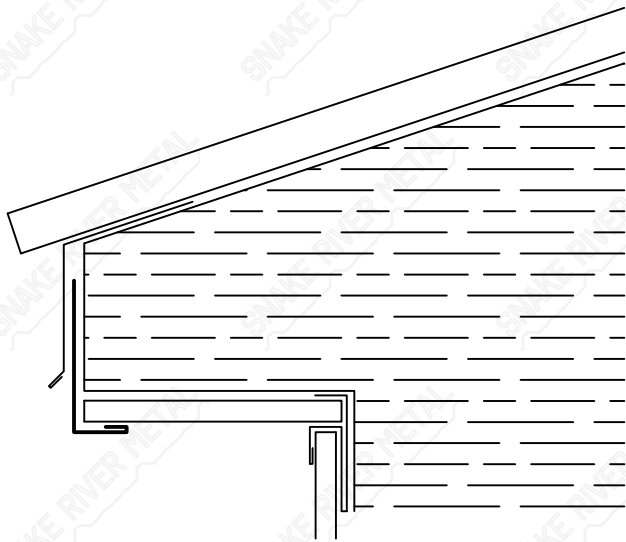
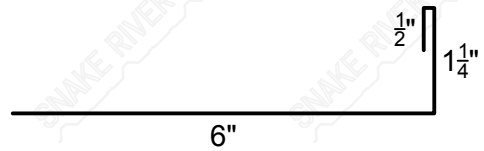

"F" Channel On Next Page

Return
To Top

"F" Channel - Spartan

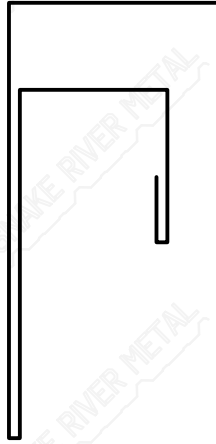

"F" Channel ($\frac{1}{2}$ " x $\frac{3}{4}$ ")

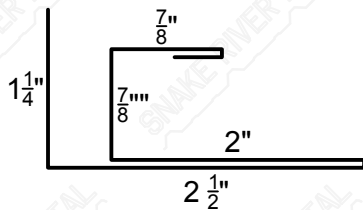

"F" Channel ($\frac{3}{4}$ " x $\frac{3}{4}$ ")

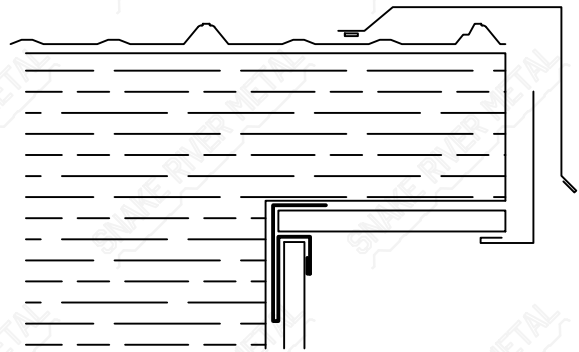
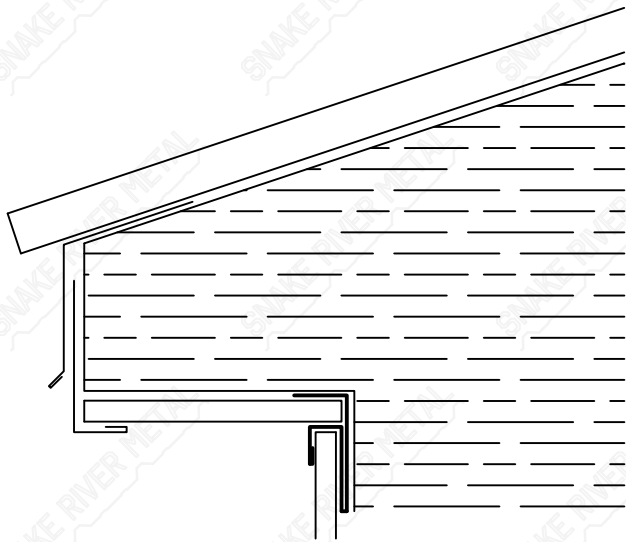
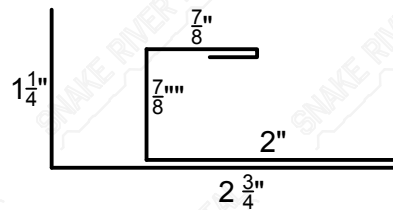

"F" Channel Continued On Next Page

Return
To Top

"F" Channel - Spartan

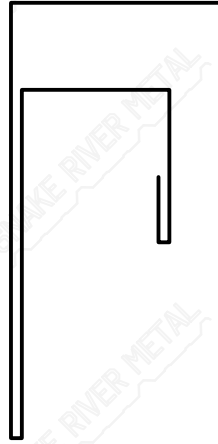

"F" Channel (1" x 3")

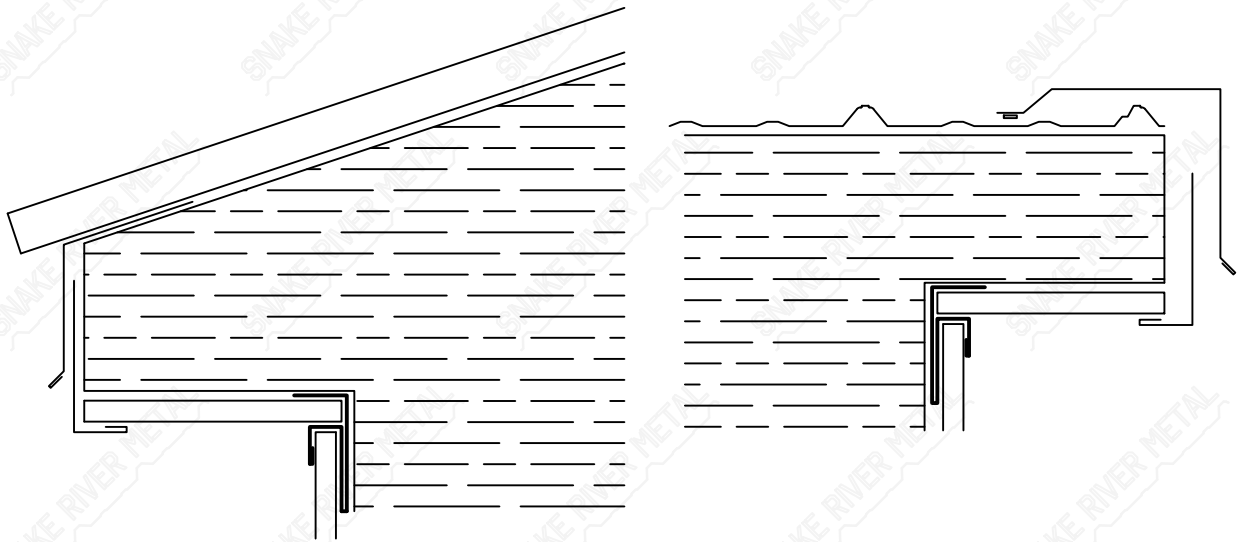
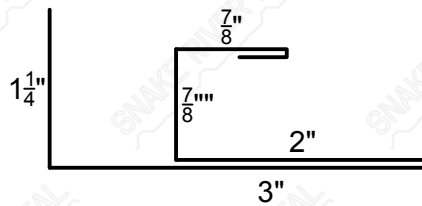

Eave On Next Page

Return
To Top

Eave - Spartan

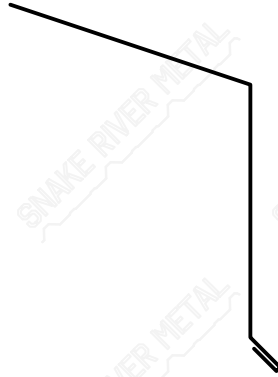

Eave

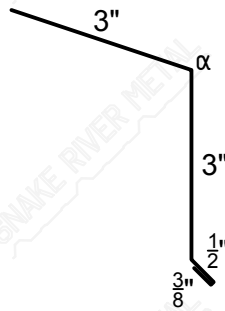

α : Specify Pitch Of Roof

Eave To Be Installed
Under Underlayment

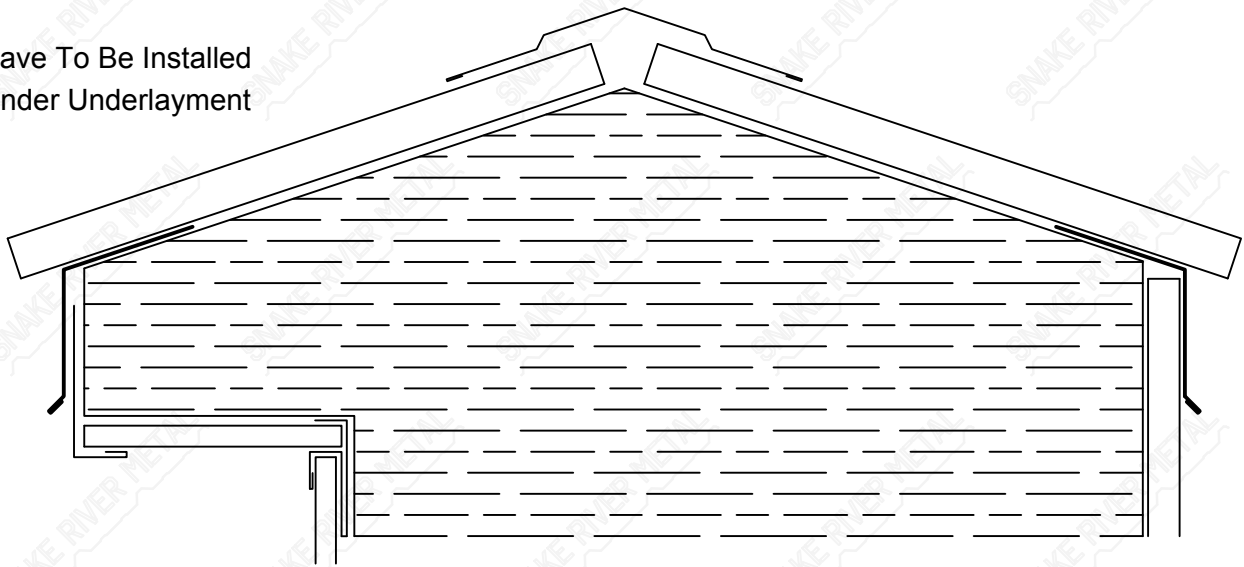

Mini Eave On Next Page

Return
To Top

Mini Eave - Spartan

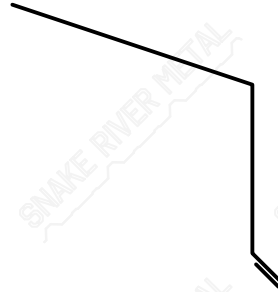

Mini Eave

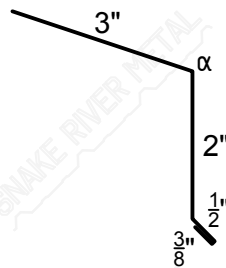

α : Specify Pitch Of Roof

Eave To Be Installed
Under Underlayment

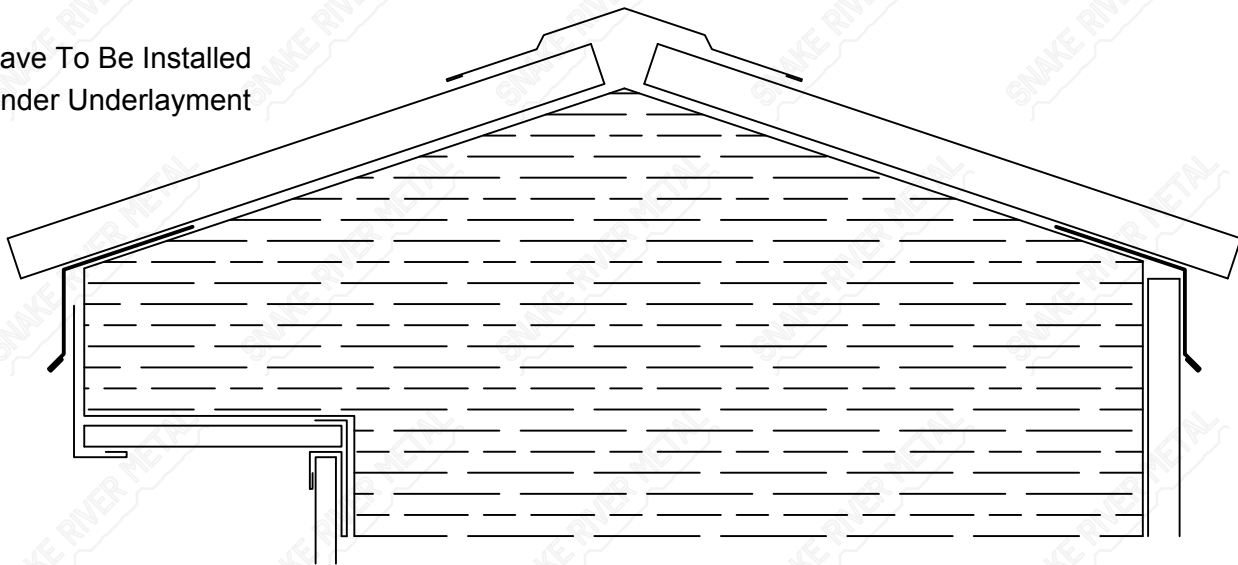

Modified Eave On Next Page

Return
To Top

Modified Eave - Spartan

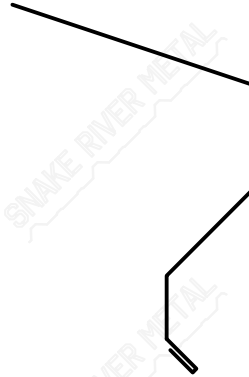

Modified Eave

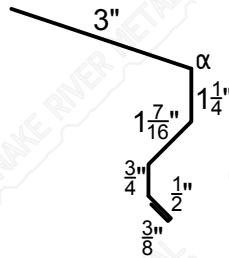

α : Specify Pitch Of Roof

Eave To Be Installed
Under Underlayment

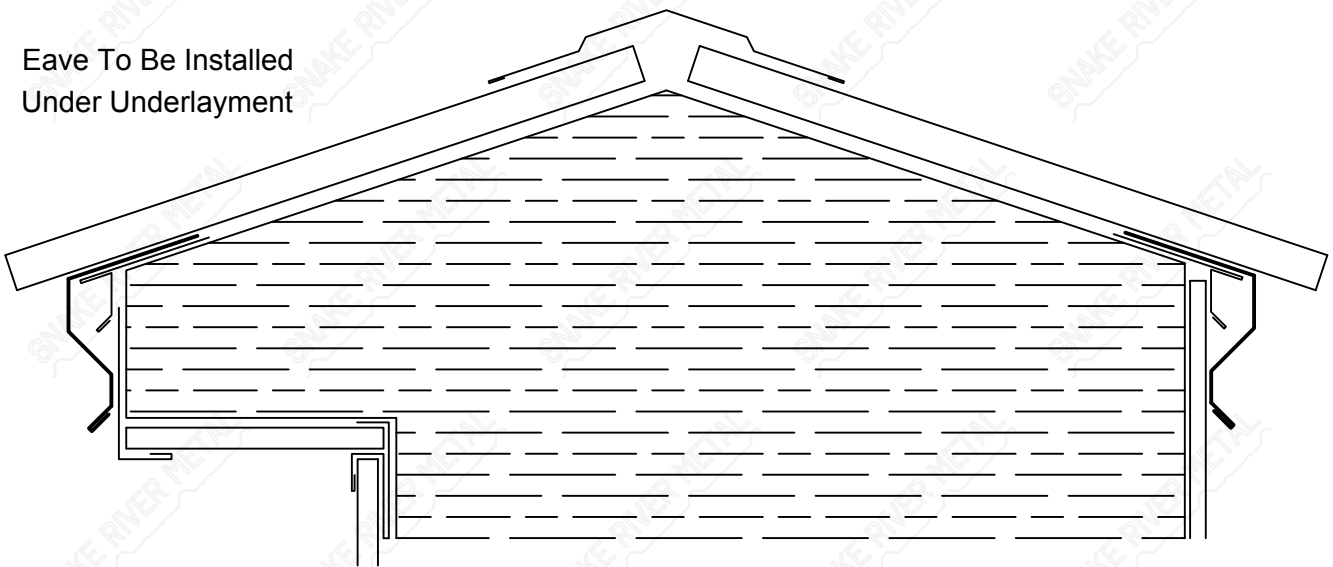

Fascia On Next Page

Return
To Top

Fascia - Spartan



Fascia (4" x 1 $\frac{1}{4}$ ")

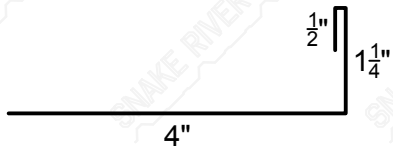

Fascia (6" x 1 $\frac{1}{4}$ ")

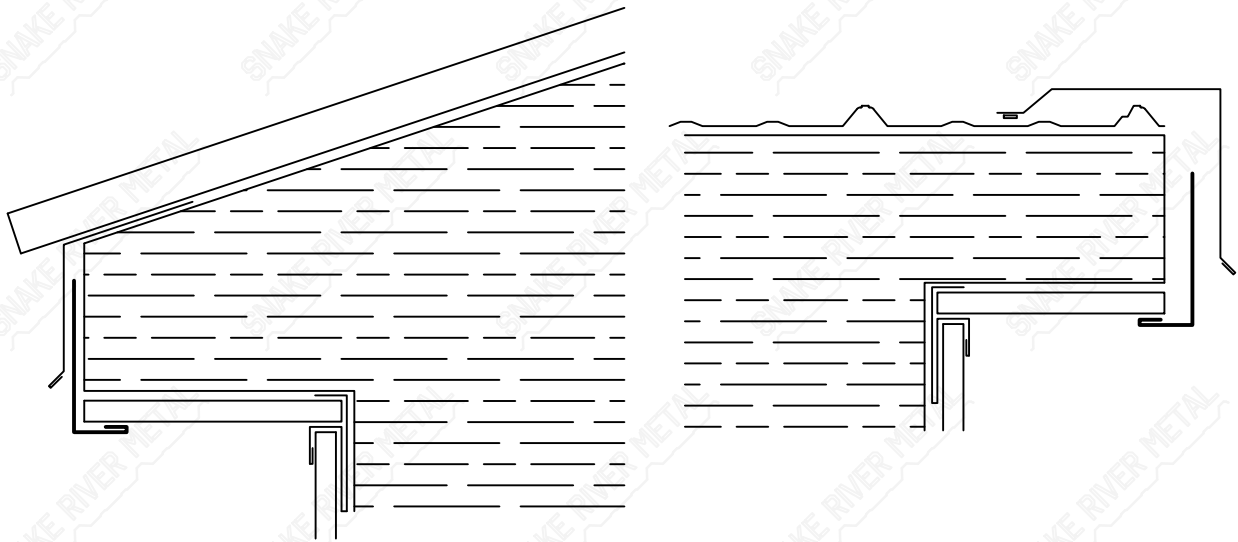
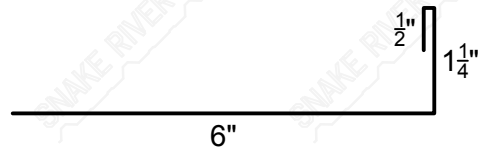

"F" Channel On Next Page

Return
To Top

"F" Channel - Spartan

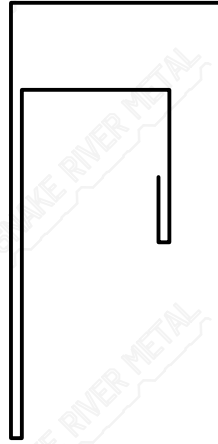

"F" Channel ($\frac{1}{2}$ " x $\frac{3}{4}$ ")

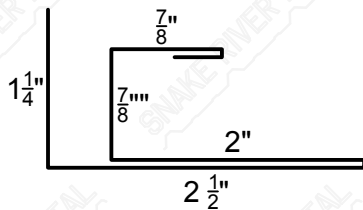

"F" Channel ($\frac{3}{4}$ " x $\frac{3}{4}$ ")

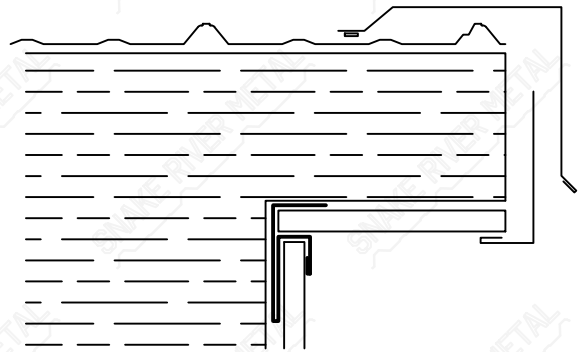
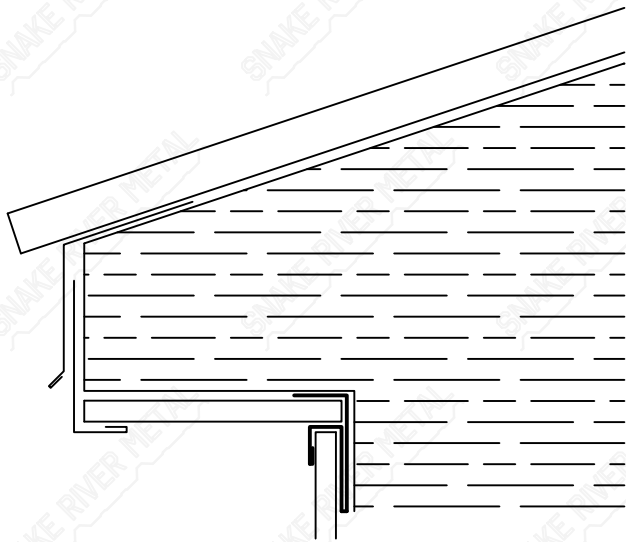
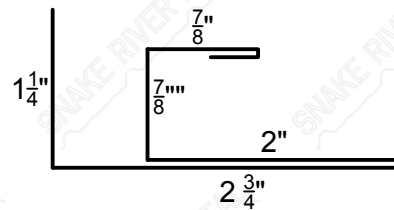

"F" Channel Continued On Next Page

Return
To Top

"F" Channel - Spartan

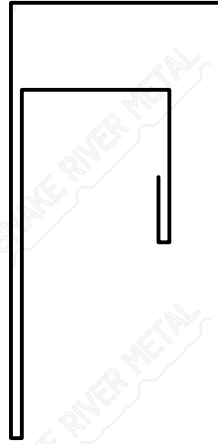

"F" Channel (1" x 3")

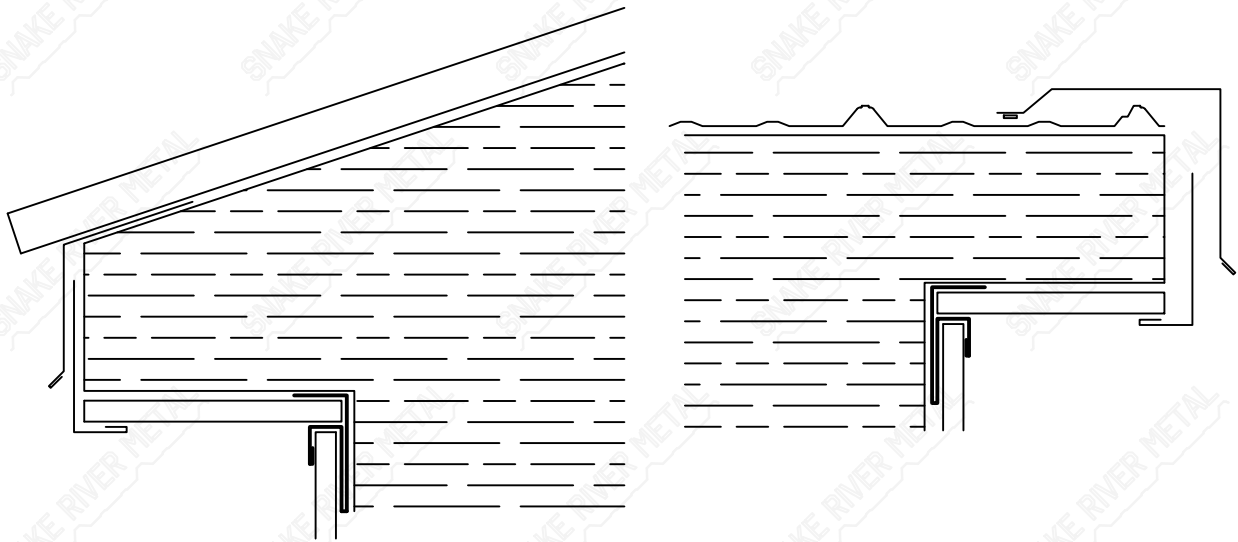
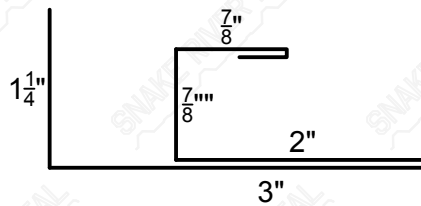

Gutter On Next Page

Return
To Top

Gutter - Spartan

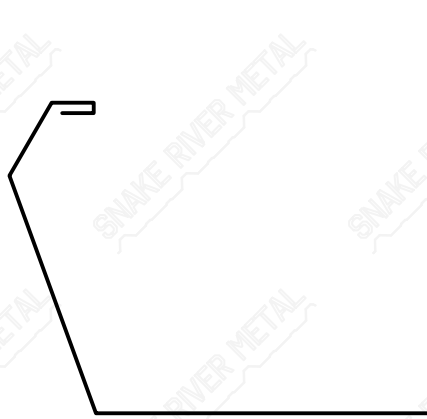

Gutter

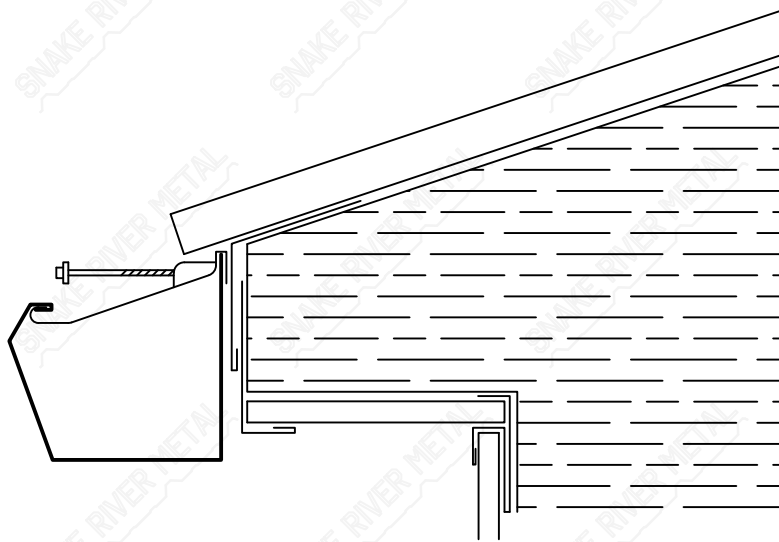
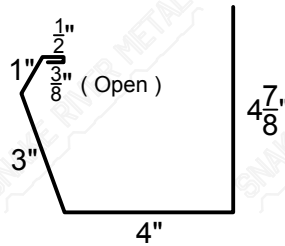

Down Spout On Next Page

Return
To Top

Down Spout - Spartan

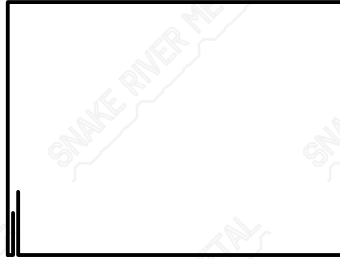

Down Spout

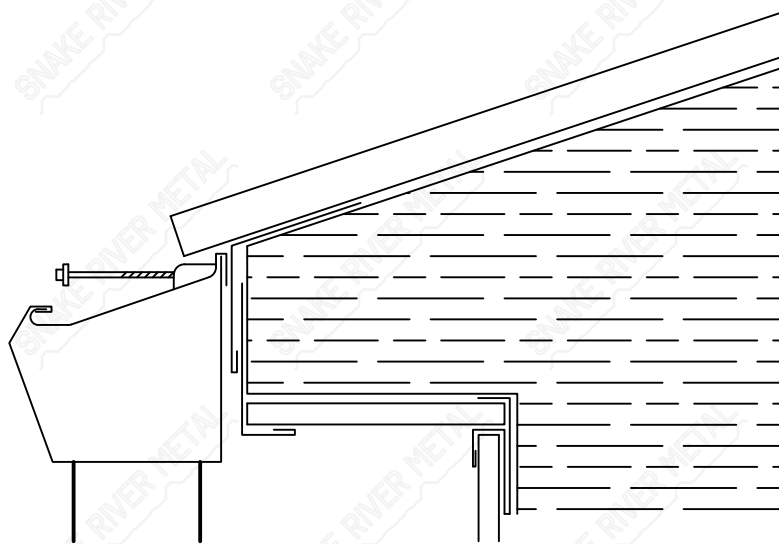
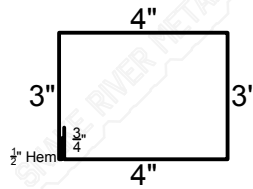

Snow Stop On Next Page

Return
To Top

Snow Stop - Spartan

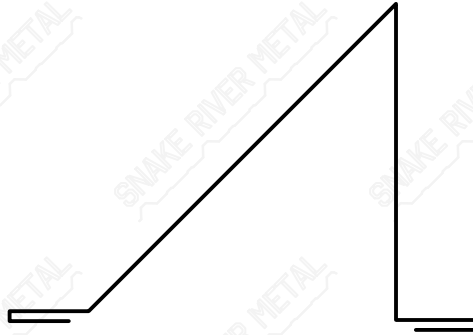

Snow Stop

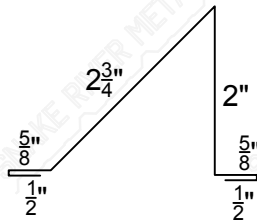

Secure Attachment To
Trusses And Substructure

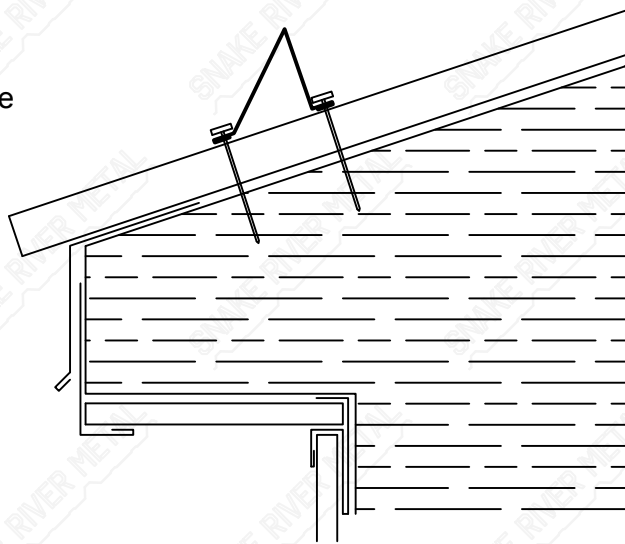

W-Valley On Next Page

Return
To Top

W-Valley - Spartan



W-Valley

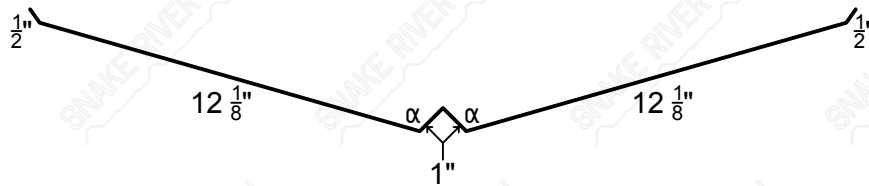

α : Specify Pitch Of Roof

Laptape Sealant
Recommended

Cut Panels 3" - 4"
From Valley

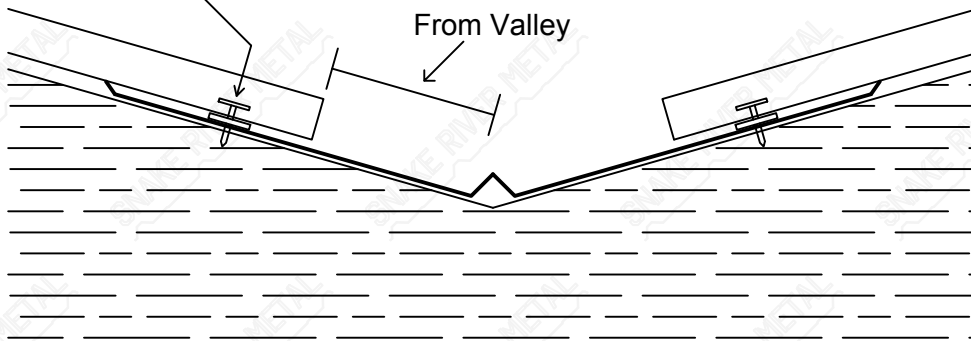

Chimney On Next Page

Return
To Top

Chimney Penetration

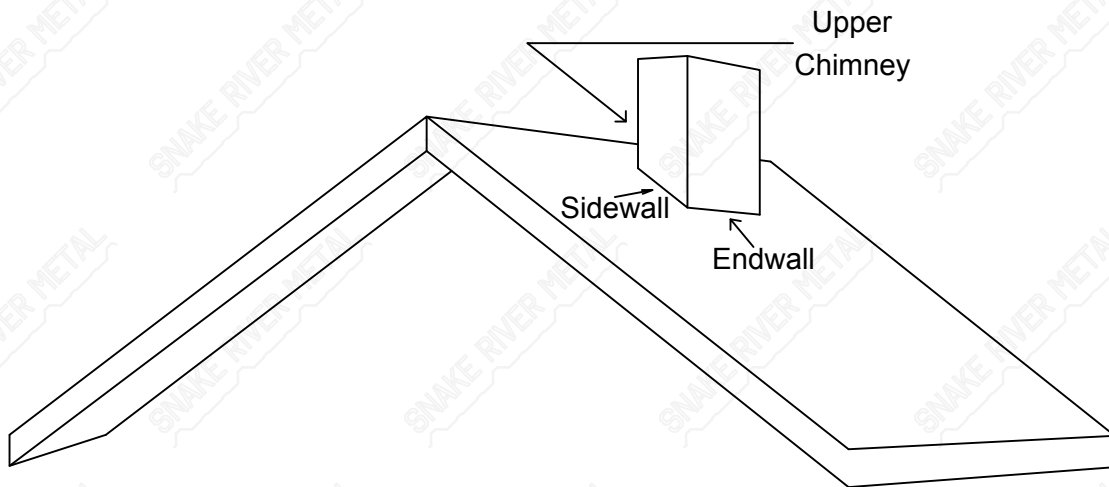

Most Chimney's Include:

Upper Chimney

Endwall

Sidewall

1 Inside Foam Closure

1 Outside Foam Closure

Upper Chimney On Next Page

Return
To Top

Upper Chimney - Spartan

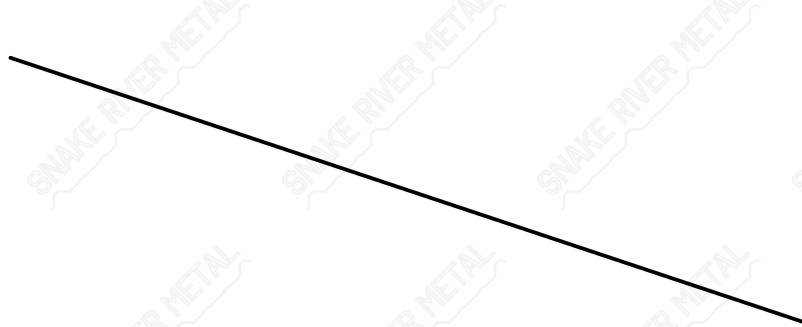

Upper Chimney

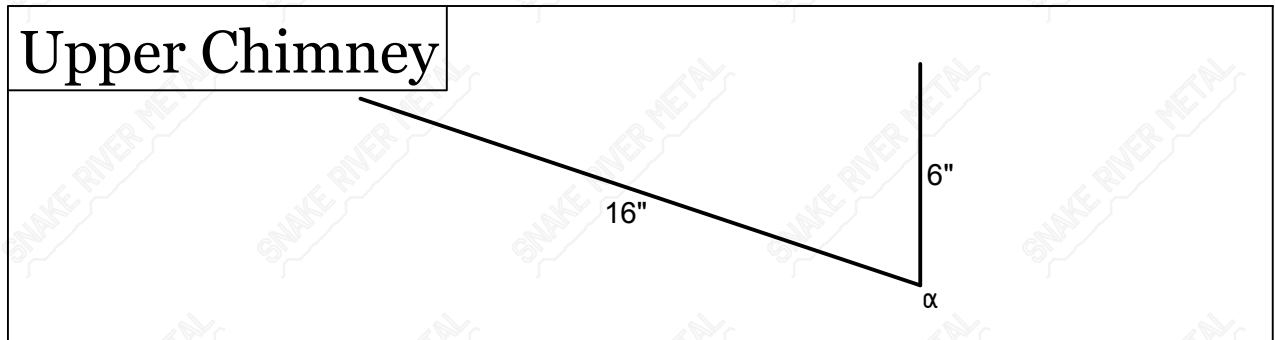

α : Specify Pitch Of Roof

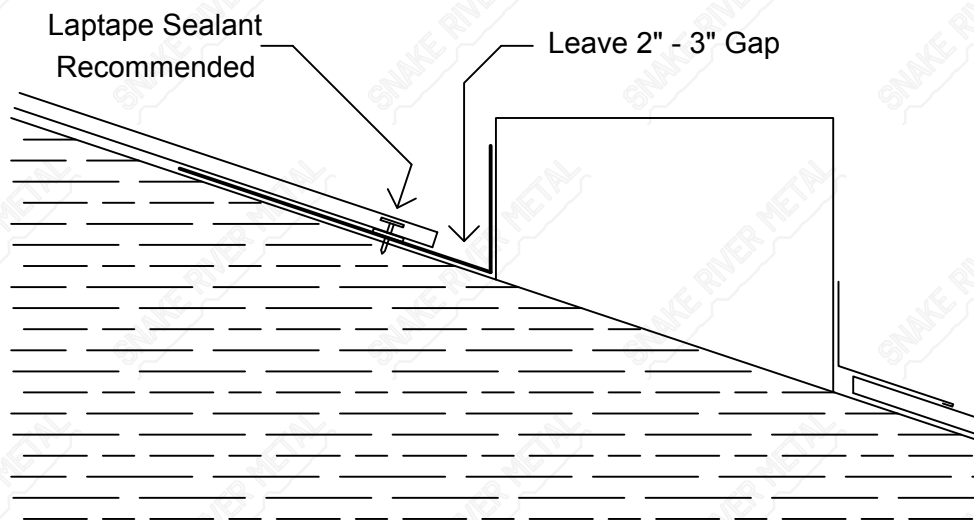

Endwall On Next Page

Return
To Top

Endwall - Spartan

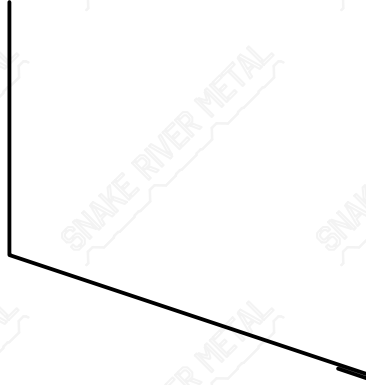

Endwall

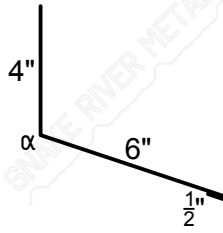

α : Specify Pitch Of Roof

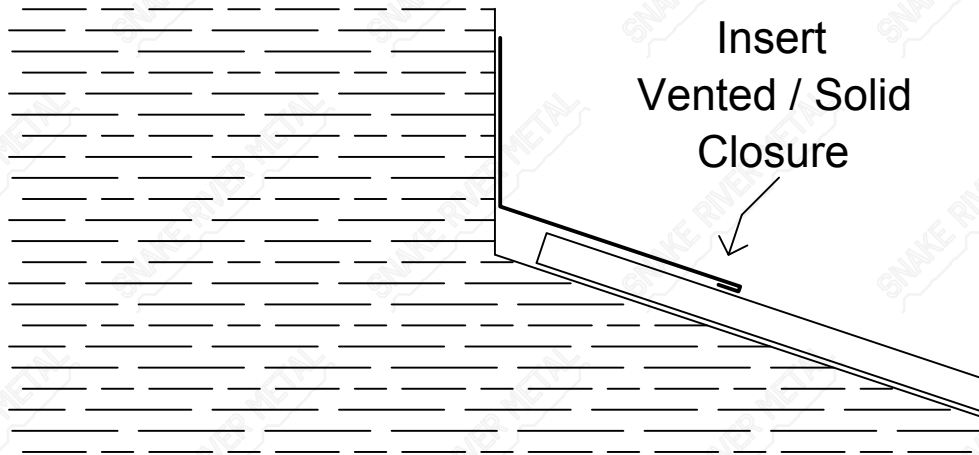

Sidewall On Next Page

Return
To Top

Sidewall - Spartan

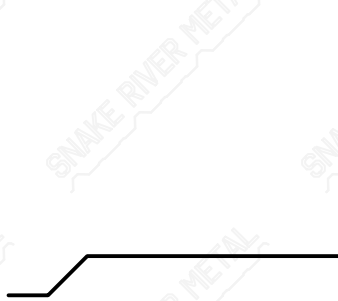

Sidewall

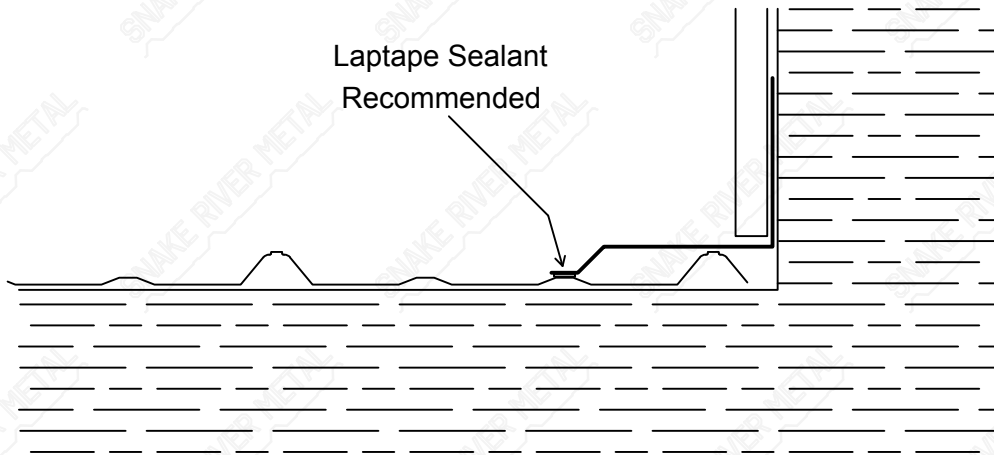
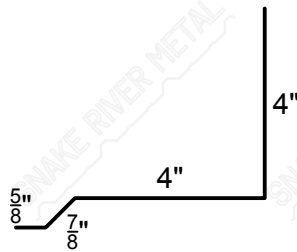

Transition On Next Page

Return
To Top

Transition - Spartan



Transition

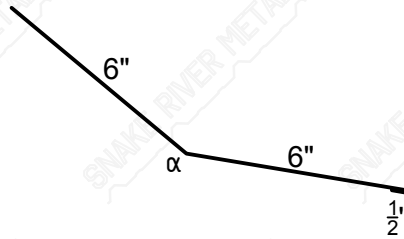

α : Specify Pitch Of Roof

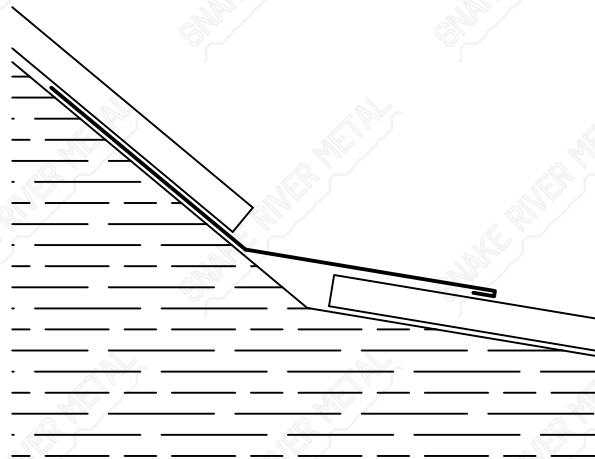

Gambrel On Next Page

Return
To Top

Gambrel - Spartan

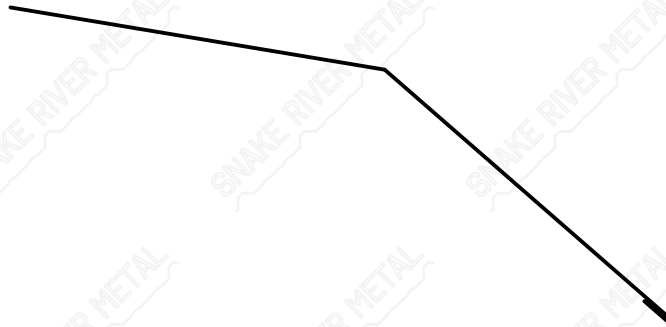

Gambrel

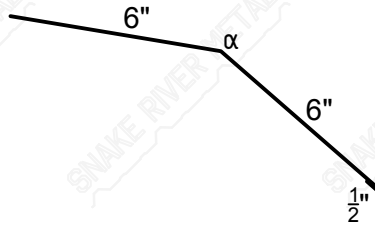

α : Specify Pitch Of Roof

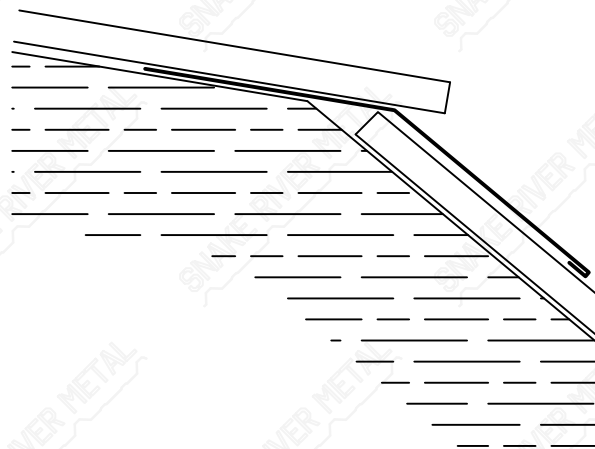

High Eave On Next Page

Return
To Top

High Eave - Spartan

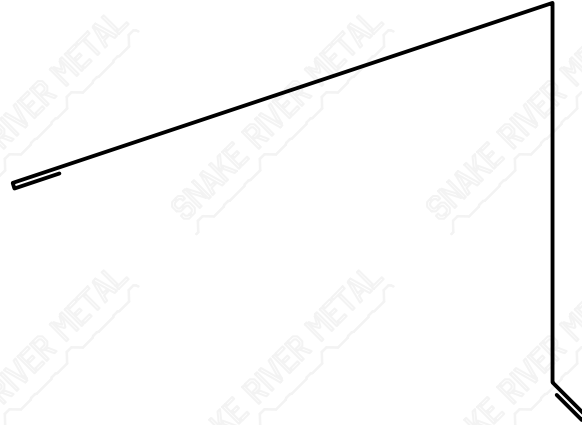

High Eave

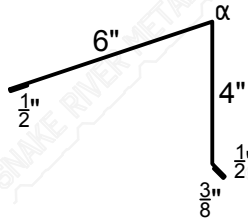

α : Specify Pitch Of Roof

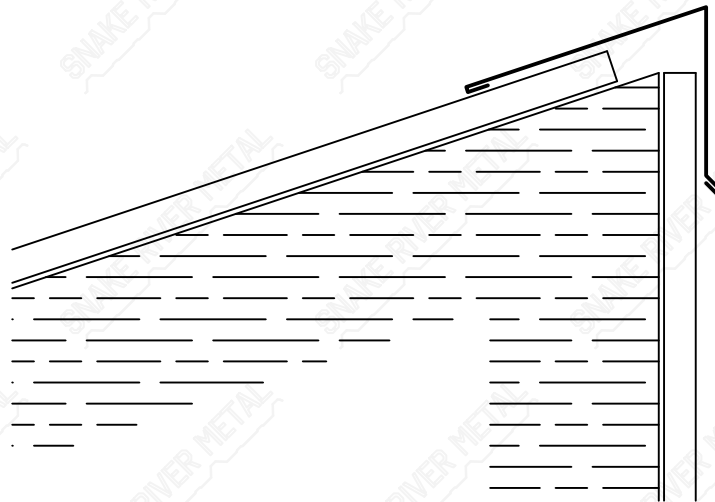

Outside Corner On Next Page

Return
To Top

Outside Corner - Spartan

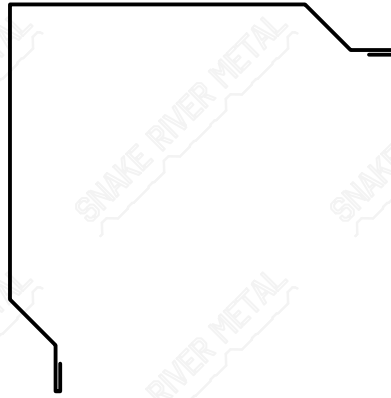

Outside Corner

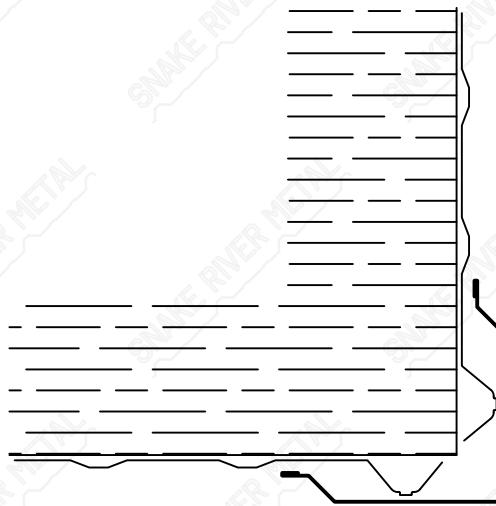
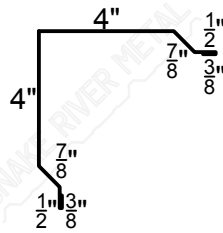

Inside Corner On Next Page

Return
To Top

Inside Corner - Spartan

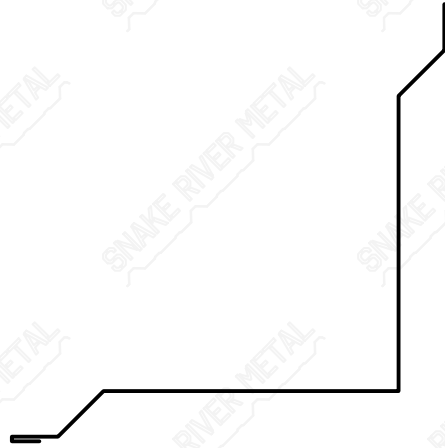

Inside Corner

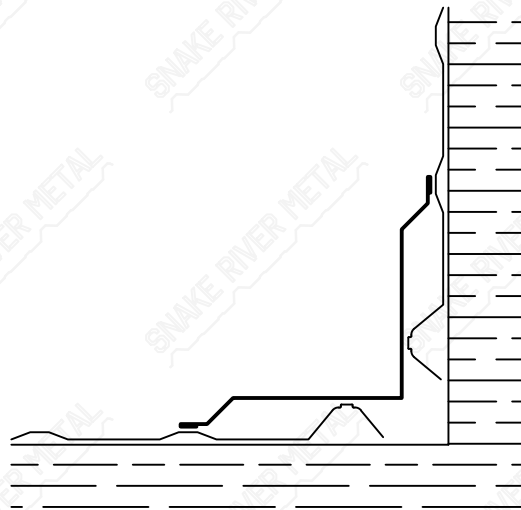
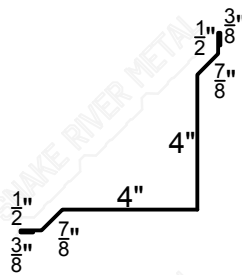

"C" Channel On Next Page

Return
To Top

"C" Channel - Spartan

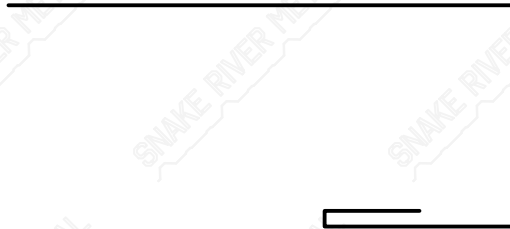

"C" Channel

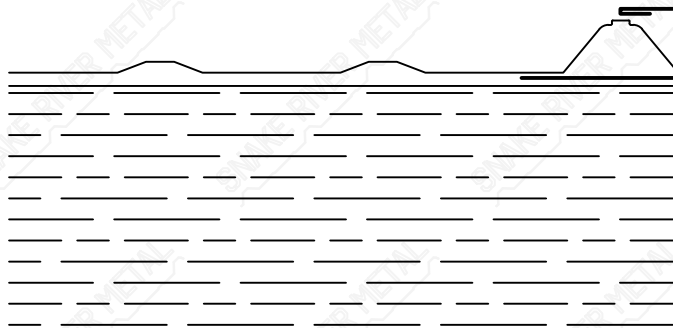
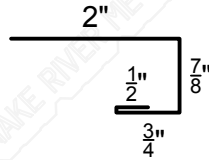

Gutter "C" On Next Page

Return
To Top

Gutter "C" - Spartan

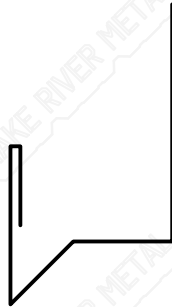

Gutter "C"

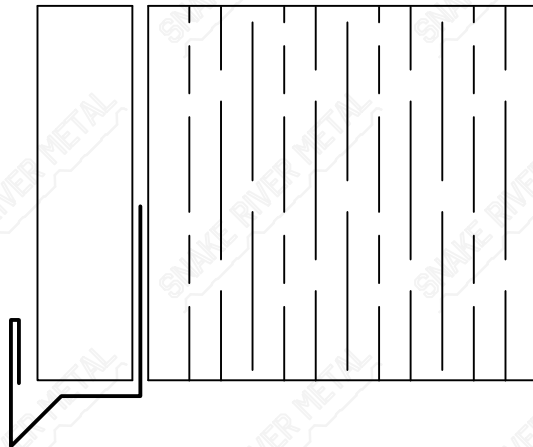
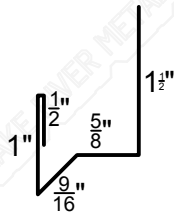

Door Jamb Wrap On Next Page

Return
To Top

Door Jamb Wrap - Spartan



DJW (1" x 6")

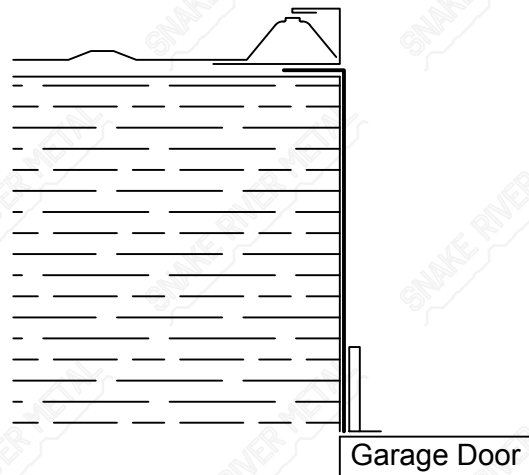

Brick Moulding On Next Page

Return
To Top

Brick Moulding - Spartan

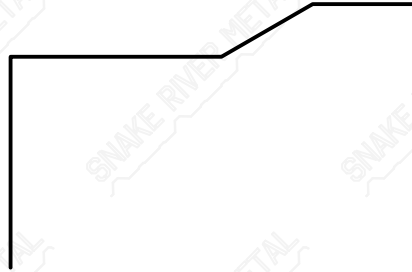

Brick Moulding

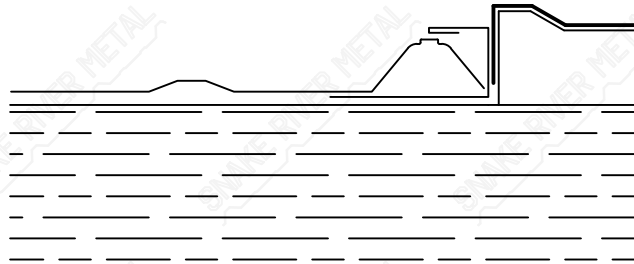
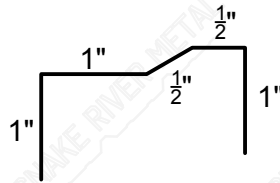

Base On Next Page

Return
To Top

Base - Spartan



Base

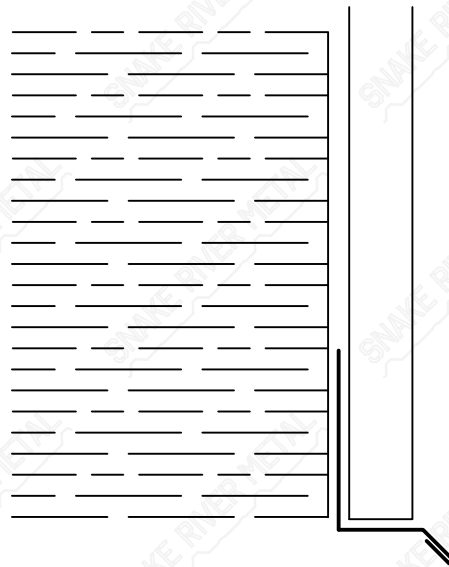
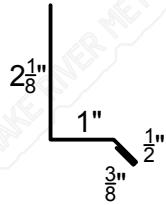

Hugger Base On Next Page

Return
To Top

Hugger Base - Spartan



Hugger Base

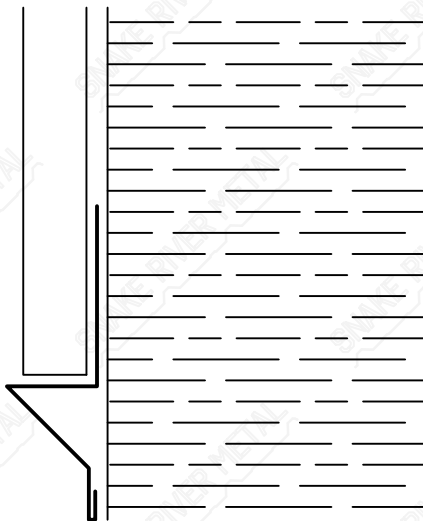
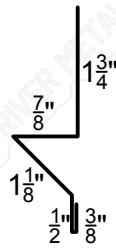

Offset Hugger Base On Next Page

Return
To Top

Offset Hugger Base - Spartan

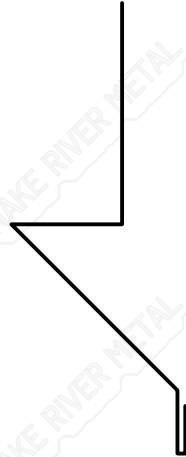

Offset Hugger Base

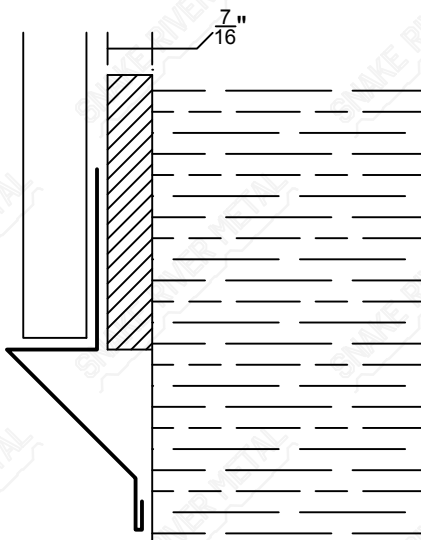
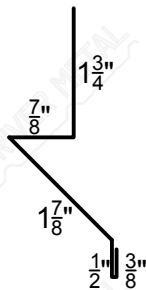

Elevated Wall Base On Next Page

Return
To Top

Elevated Wall Base - Spartan



Elevated Wall Base

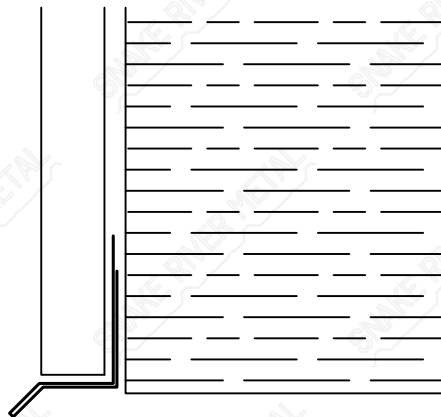
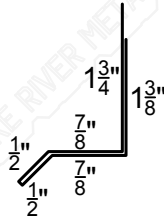

Soffit Wall Base On Next Page

Return
To Top

Soffit Wall Base - Spartan

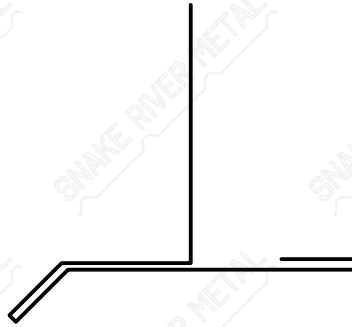

Soffit Wall Base

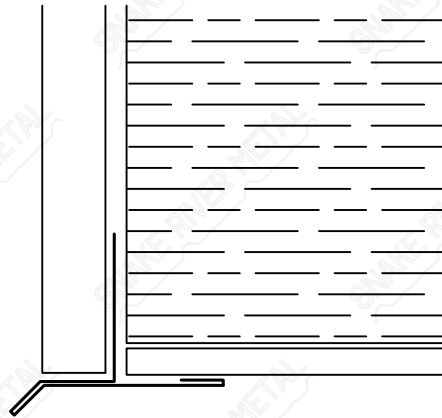
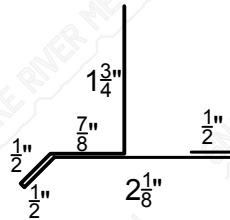

Zee Transition On Next Page

Return
To Top

Zee Transition - Spartan



Zee Transition

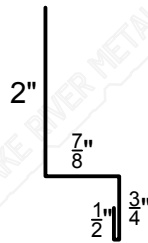

Barn Door Track Cover On Next Page

Return
To Top

Barn Door Track Cover

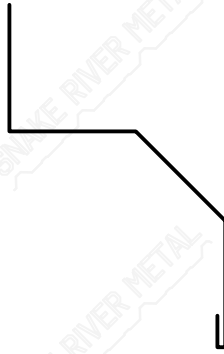

Track Cover

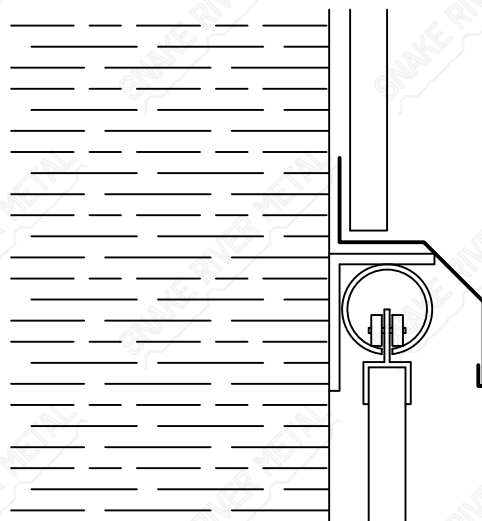
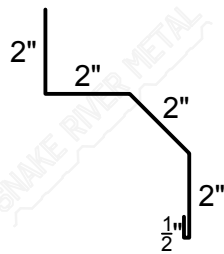

Post Wrap - 1 Piece On Next Page

Return
To Top

Post Wrap - 1 Piece

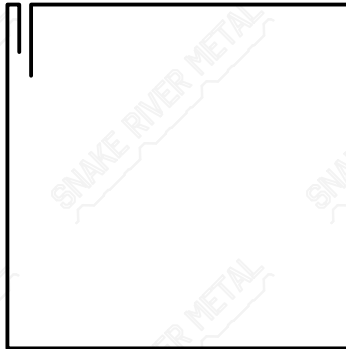

Post Wrap

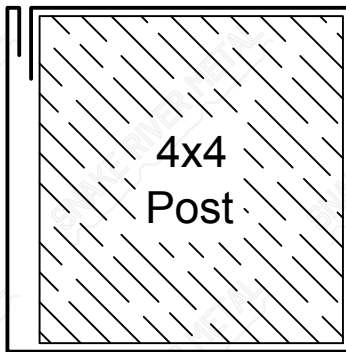
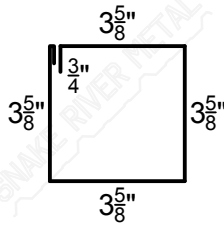

Post Wrap - 2 Piece On Next Page

Return
To Top

Post Wrap - 2 Piece

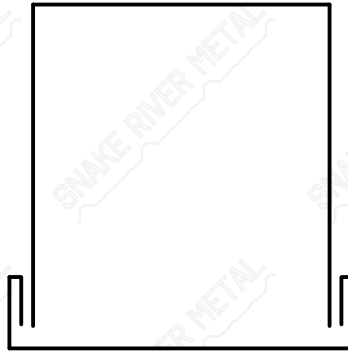

Post Wrap

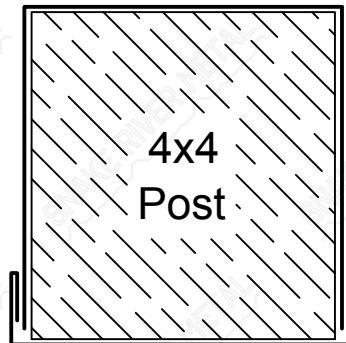
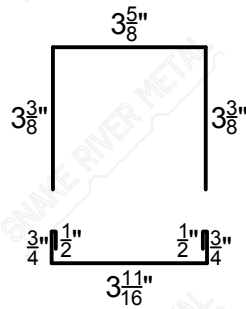

Parapet Cap On Next Page

Return
To Top

Parapet Cap



Parapet Cap

(Specify Dimension)

