

# **SNAKE RIVER METAL**



## **STANDARD TRIM LIST FLANGE LOCK PANEL**



# SNAKE RIVER METAL

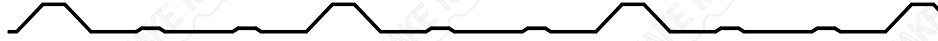

## FLANGE LOCK 1"

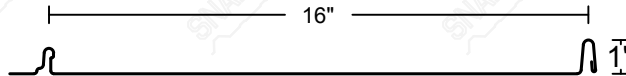

**FASTENERS: CONCEALED**

**COVERAGE: 16" OR 12"**

**MINIMUM PITCH: 3:12**

**MINIMUM LENGTH: 4'-0"**

**MATERIAL THICKNESS: 26G**

**FINISH: 40 YEAR SMP**

**ATTACHMENT TYPE: FLANGE**

**STRIATIONS ( RECOMMENDED )**



**MINORS ( OPTIONAL )**



**FLAT PAN ( PRONE TO OIL CANNING )**



**12" STRIATED ( SPECIALTY )**



**12" FLAT ( SPECIALTY )**

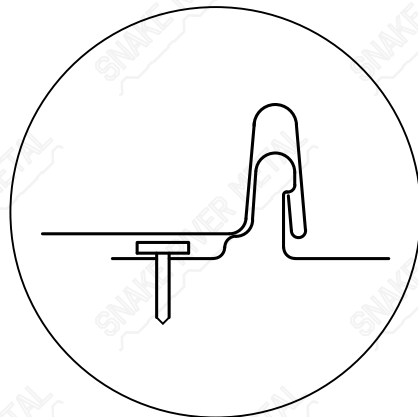

# Common Building Geometries

( Click On Building That Best Matches Your Projects Geometry )

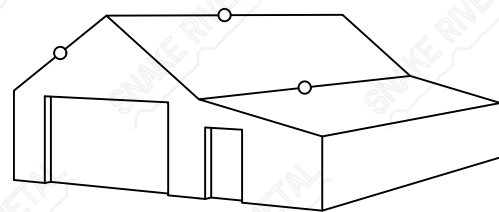
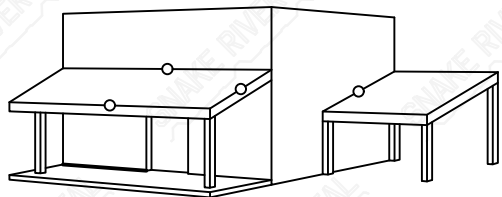
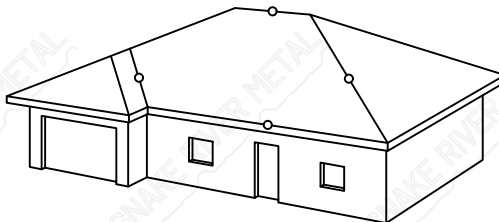
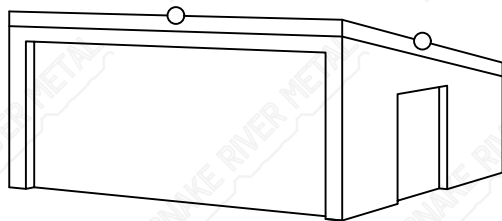
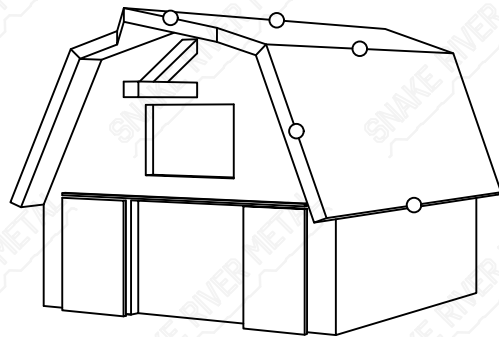
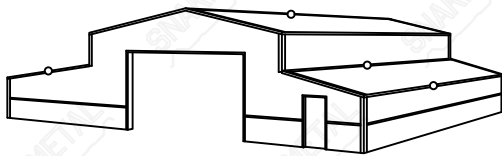
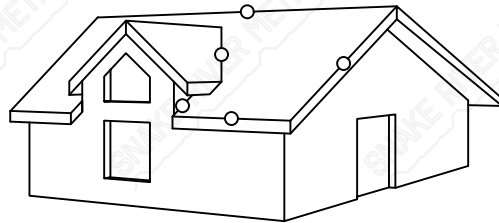
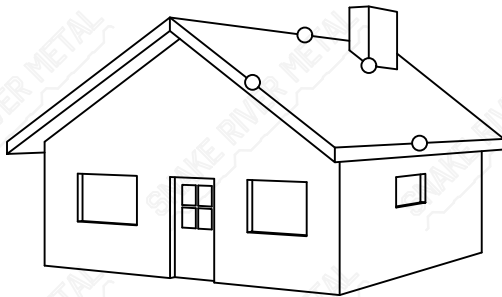

Gable Building Geometry On Next Page

Return  
To Top

# Gable Building Geometry

( Click On Circle That Best Matches Trim Location )

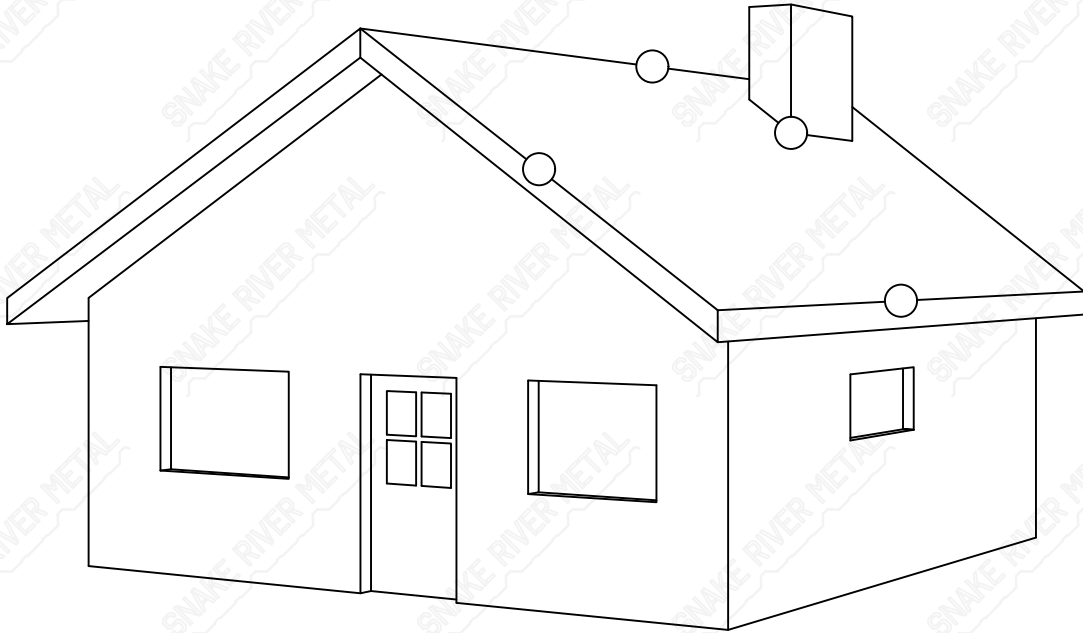

Dormer Building Geometry On Next Page

Return  
To Top

# Dormer Building Geometry

( Click On Circle That Best Matches Trim Location )

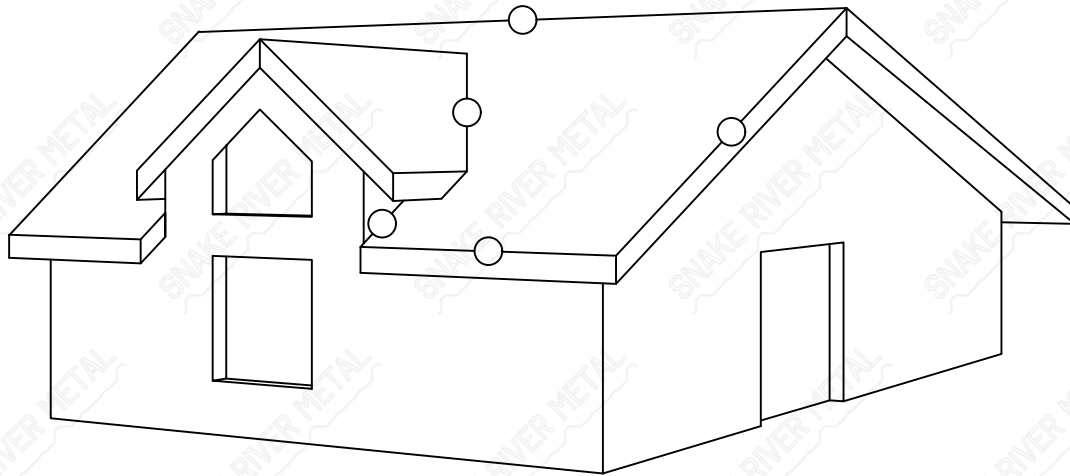

American Barn Geometry On Next Page

Return  
To Top

# American Barn Geometry

( Click On Circle That Best Matches Trim Location )

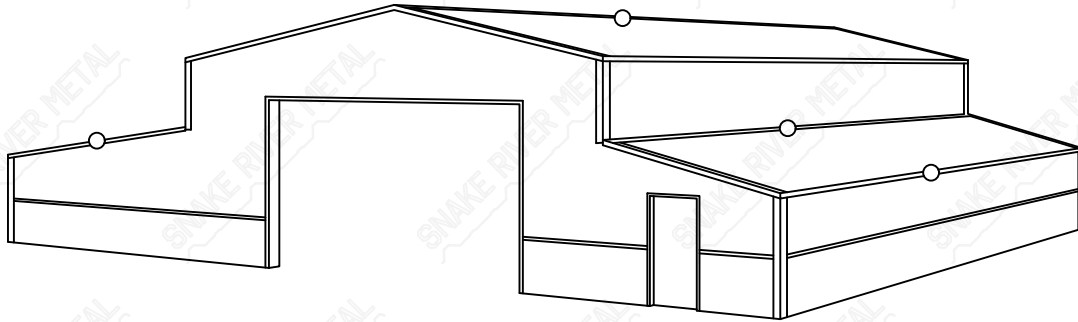

Gambrel Building Geometry On Next Page

Return  
To Top

# Gambrel Building Geometry

( Click On Circle That Best Matches Trim Location )

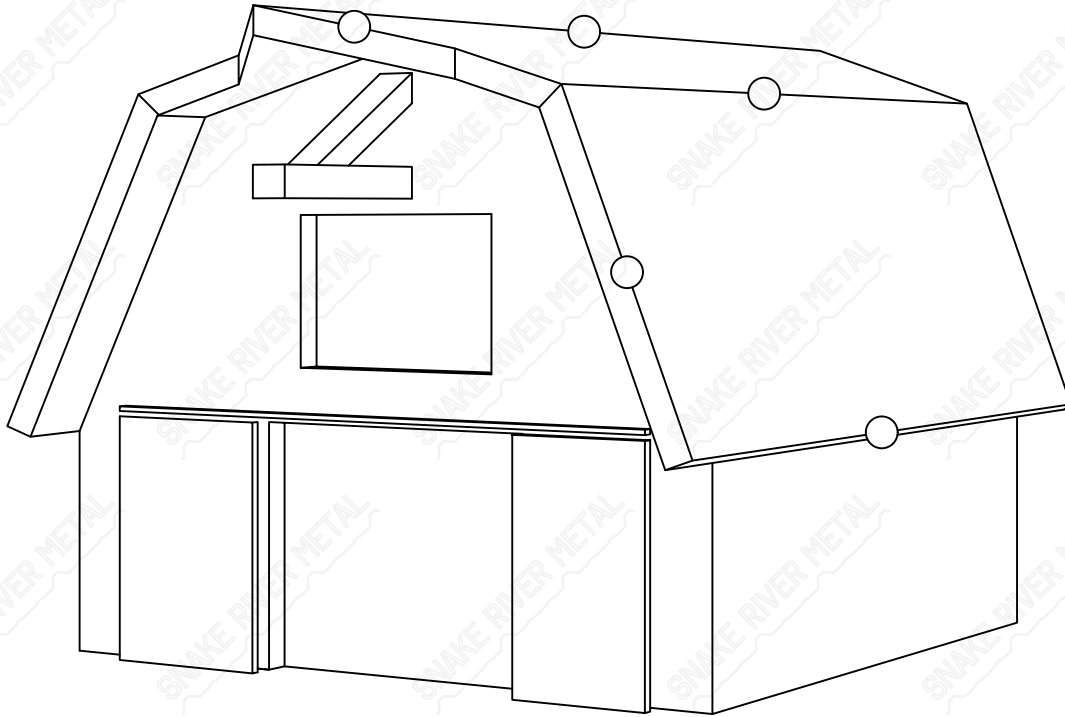

Single Slope Shed Geometry On Next Page

Return  
To Top

# Single Slope Shed Geometry

( Click On Circle That Best Matches Trim Location )

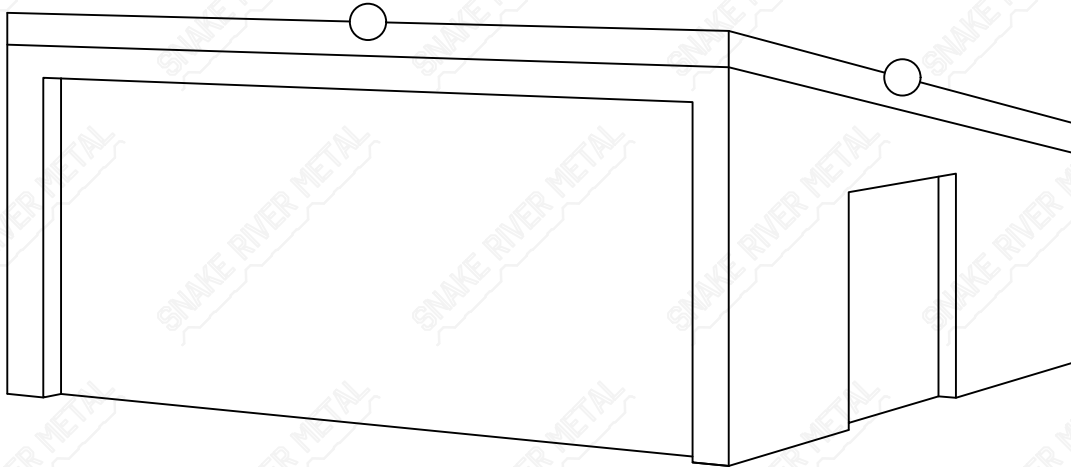

Hip Roof Geometry On Next Page



Return  
To Top

# Hip Roof Geometry

( Click On Circle That Best Matches Trim Location )

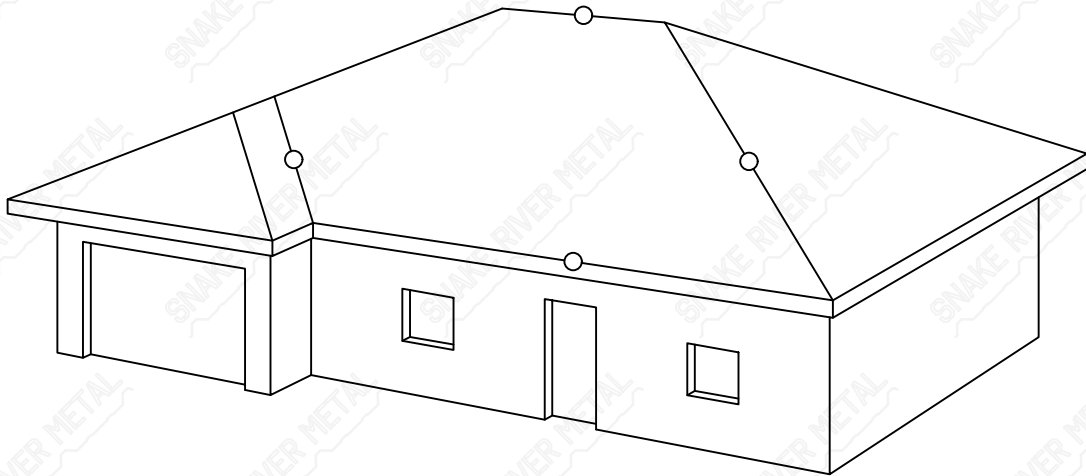

Leanto Building Geometry On Next Page

Return  
To Top

# Leanto Building Geometry

( Click On Circle That Best Matches Trim Location )

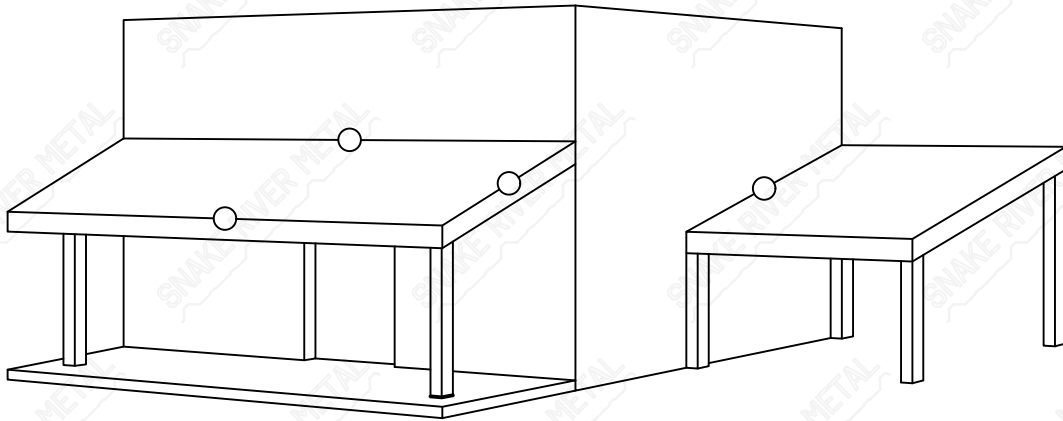

Transition Building Geometry On Next Page

Return  
To Top

# Transition Building Geometry

( Click On Circle That Best Matches Trim Location )

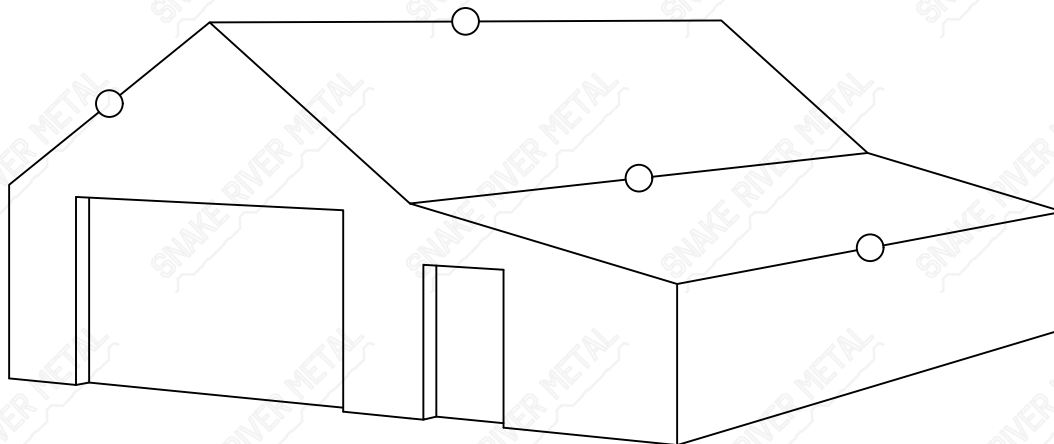

Ridge Cap On Next Page

Return  
To Top

# Ridge - Flange Lock



## Ridge

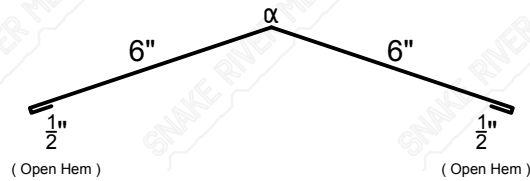

$\alpha$ : Specify Pitch Of Roof

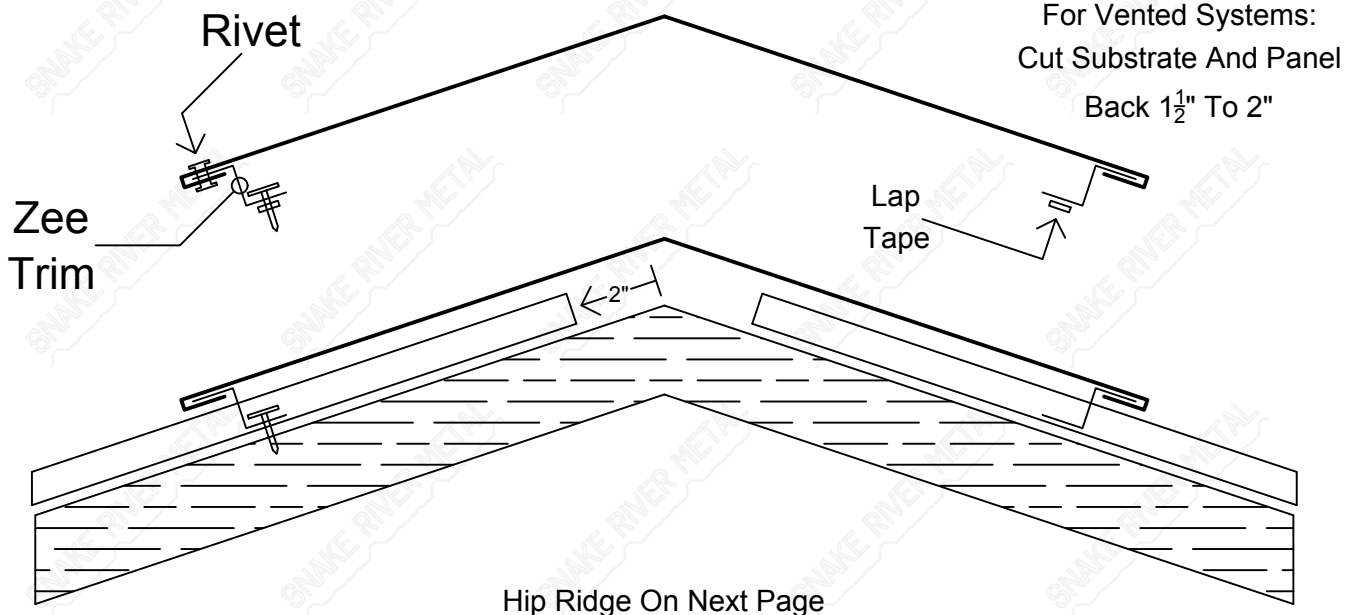

Hip Ridge On Next Page

Return  
To Top

# Hip Ridge - Flange Lock

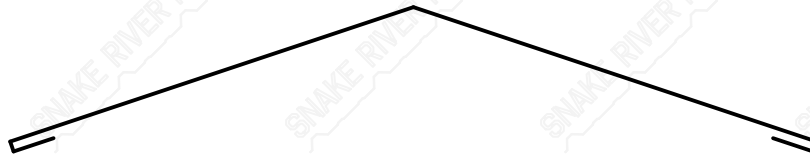

## Hip Ridge

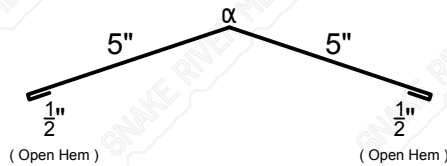

α: Specify Pitch Of Roof

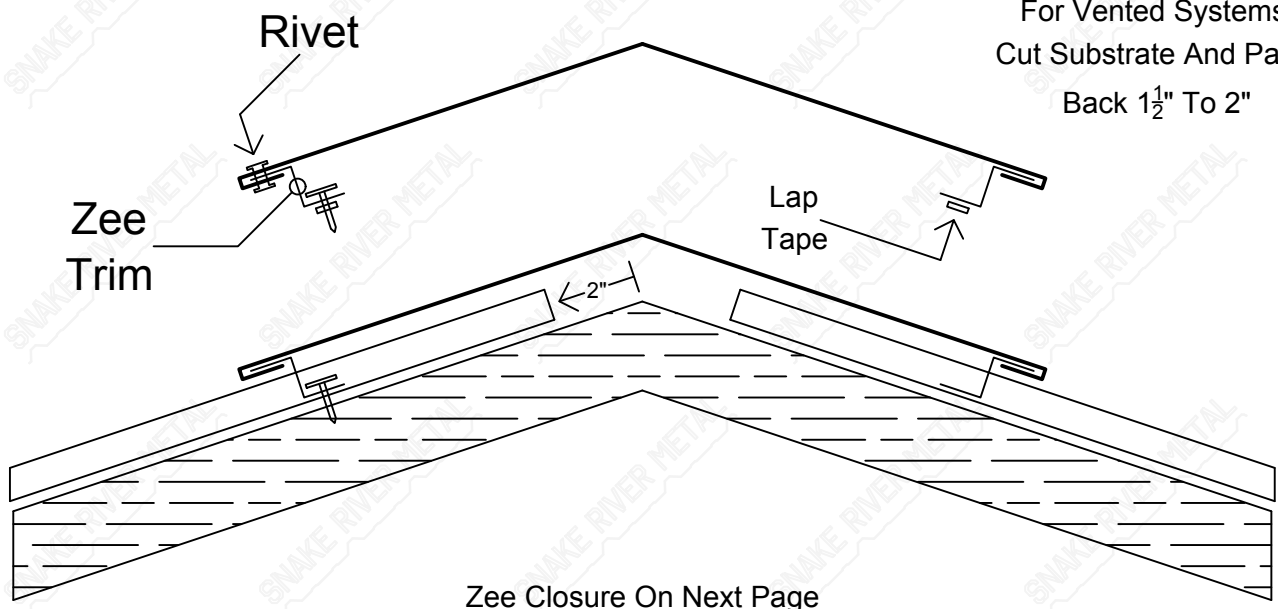

Return  
To Top

# Zee Closure - Flange Lock

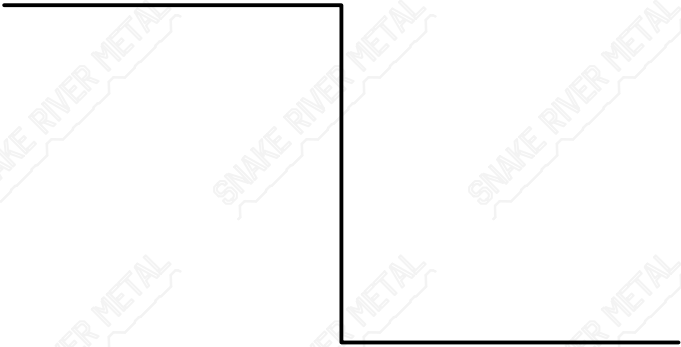

## Zee Closure

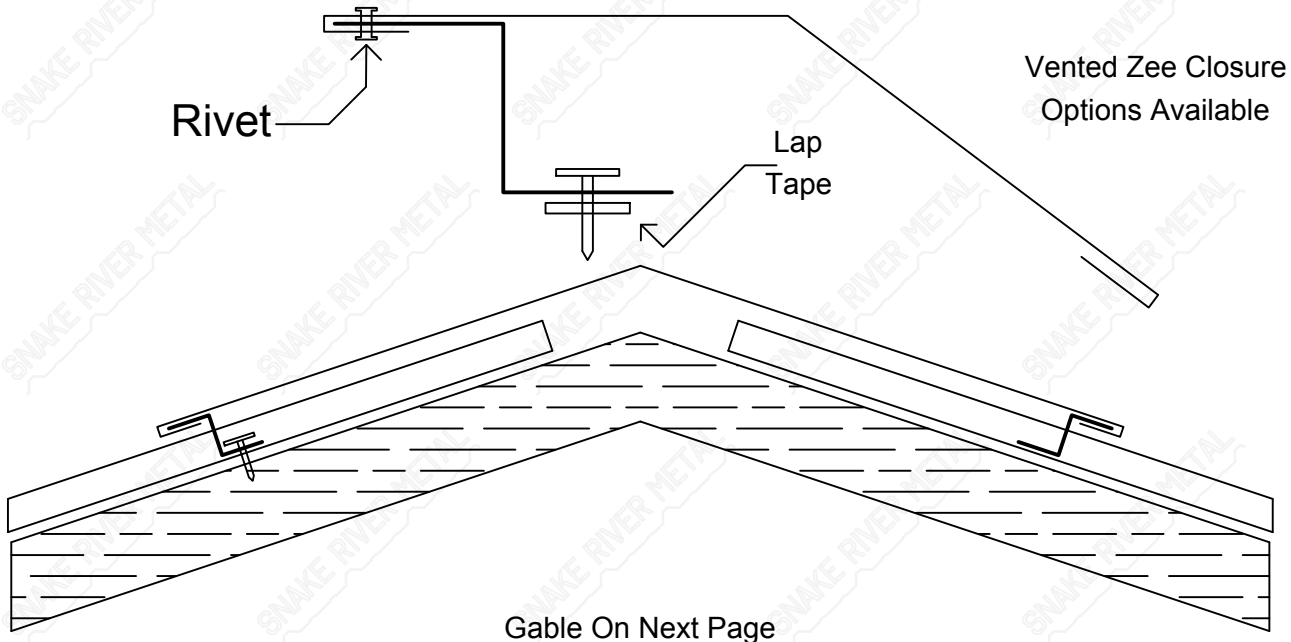
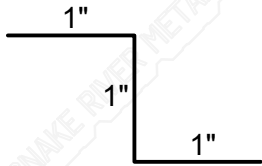

Gable On Next Page

Return  
To Top

# Gable - Flange Lock

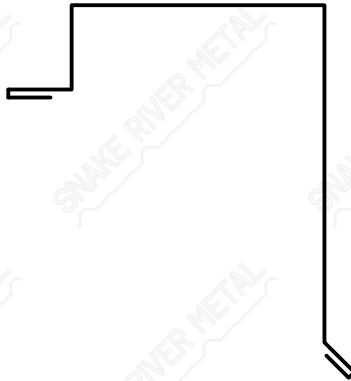

Gable

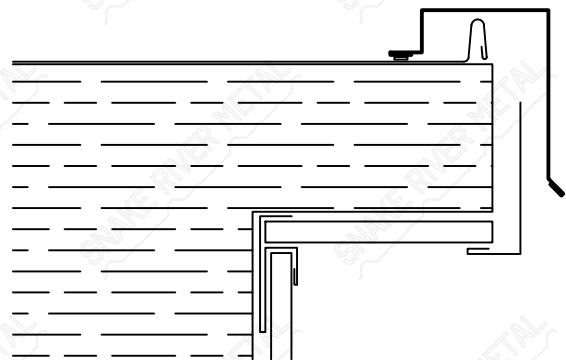
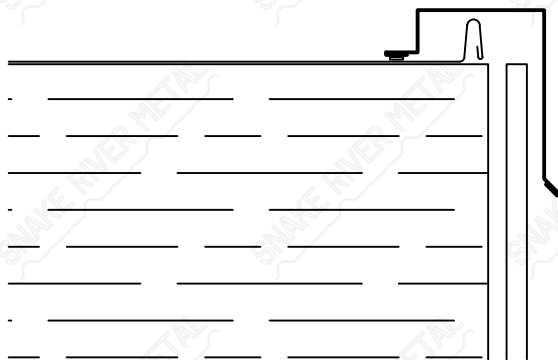
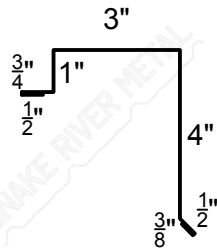

Mini Gable On Next Page

Return  
To Top

# Mini Gable - Flange Lock

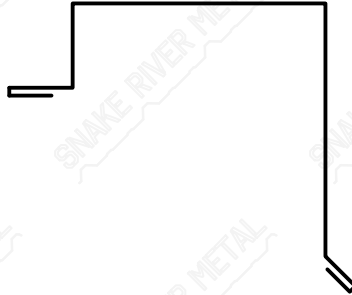

## Mini Gable

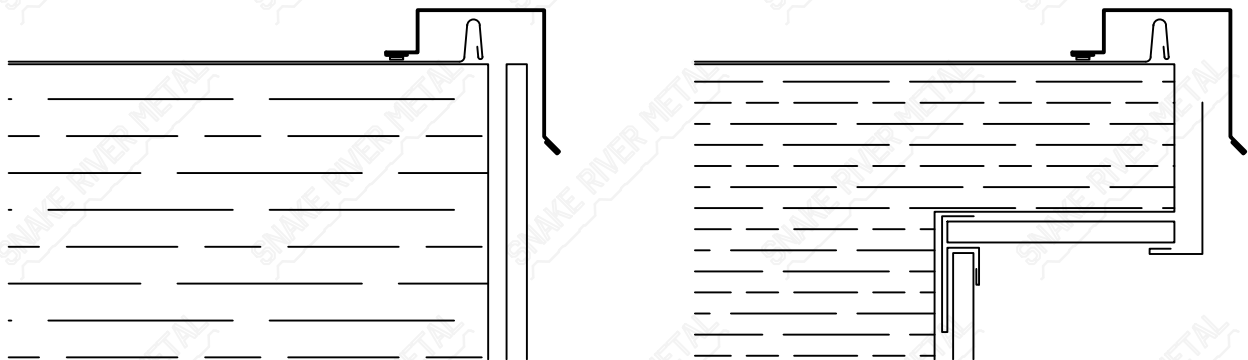
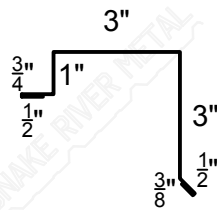

Modified Gable On Next Page



Return  
To Top

# Modified Gable - Flange Lock

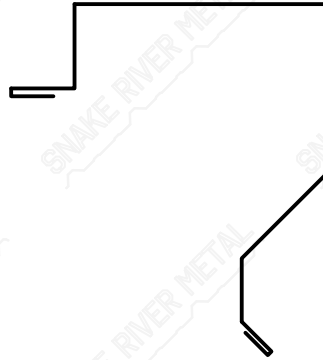

## Modified Gable

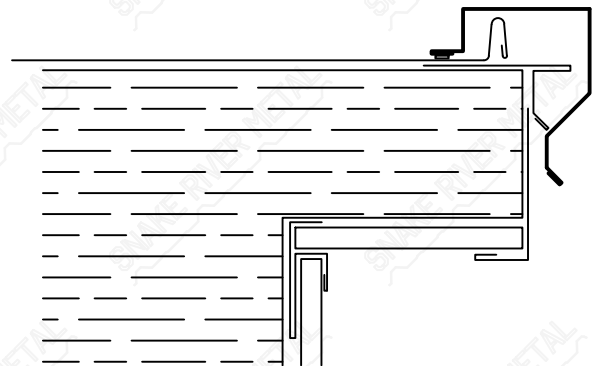
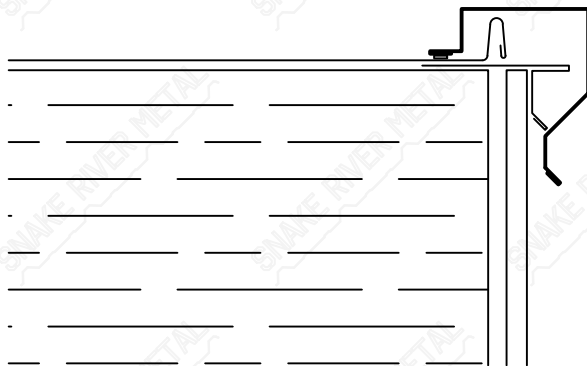
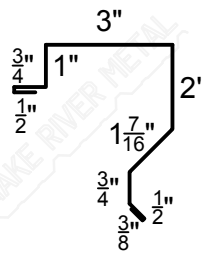

Swept Wing Gable On Next Page

Return  
To Top

# Swept Wing Gable - Flange Lock

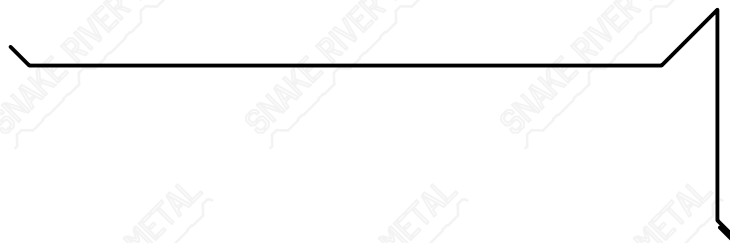

## Swept Wing Gable

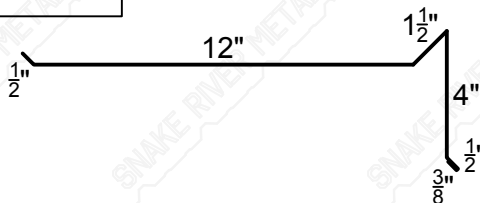

Laptape Sealant  
Recommended

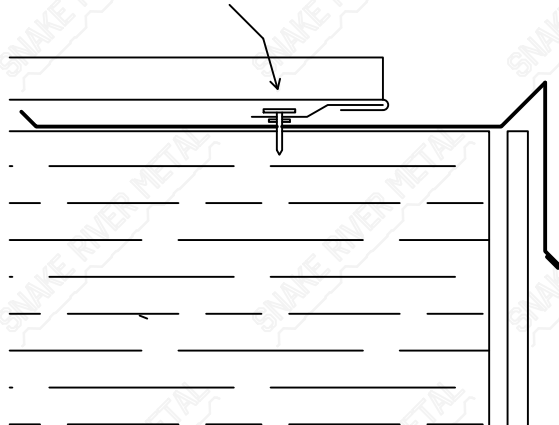

Laptape Sealant  
Recommended

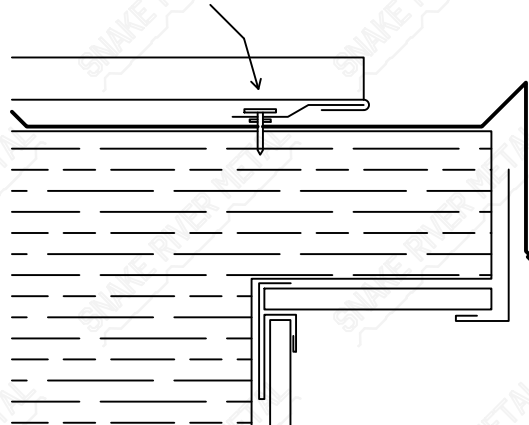

Fascia On Next Page

Return  
To Top

# Fascia - Flange Lock



Fascia ( 4" x 1  $\frac{1}{4}$ " )

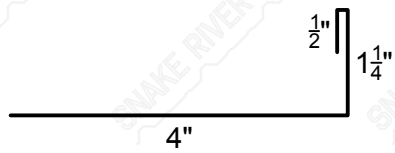

Fascia ( 6" x 1  $\frac{1}{4}$ " )

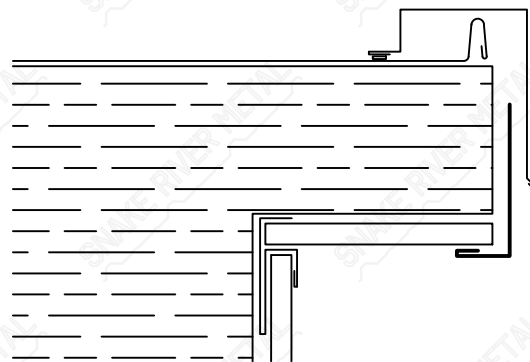
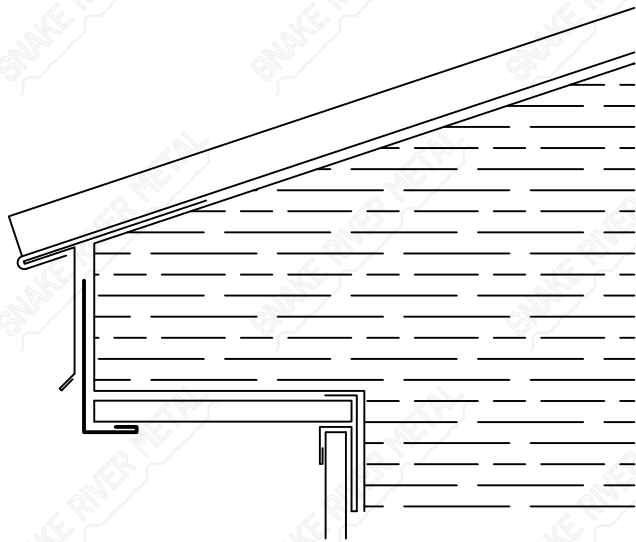
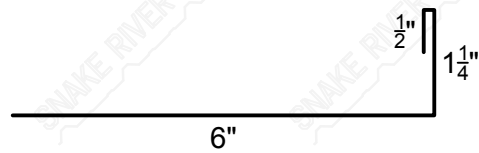

CF Eave On Next Page

Return  
To Top

# CF Eave - Flange Lock

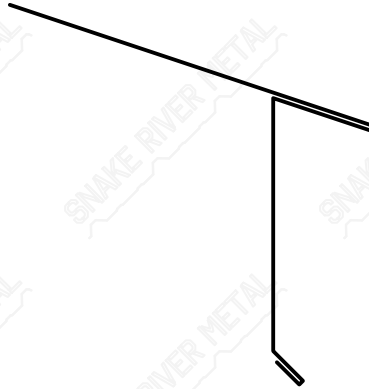

## CF Eave

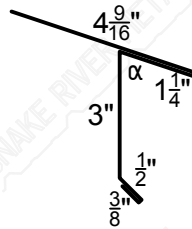

$\alpha$ : Specify Pitch Of Roof

Eave To Be Installed  
Under Underlayment

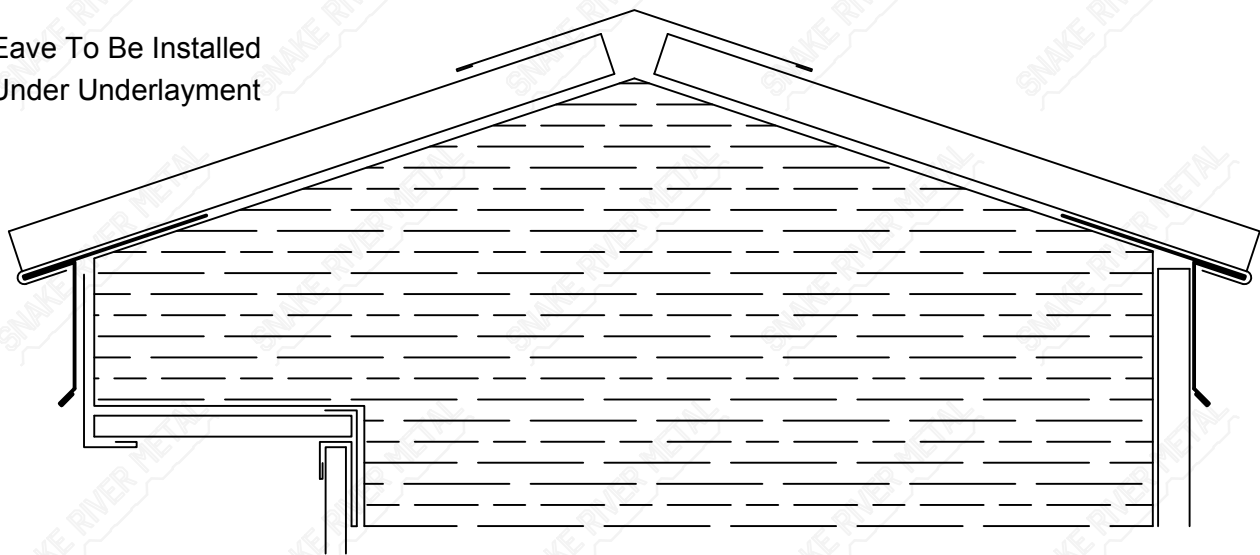

CF Mini Eave On Next Page

Return  
To Top

# CF Mini Eave - Spartan

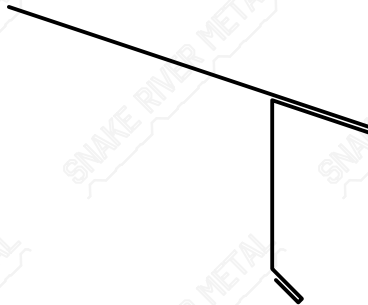

## CF Mini Eave

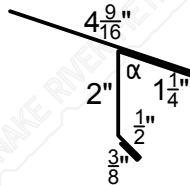

$\alpha$ : Specify Pitch Of Roof

Eave To Be Installed  
Under Underlayment

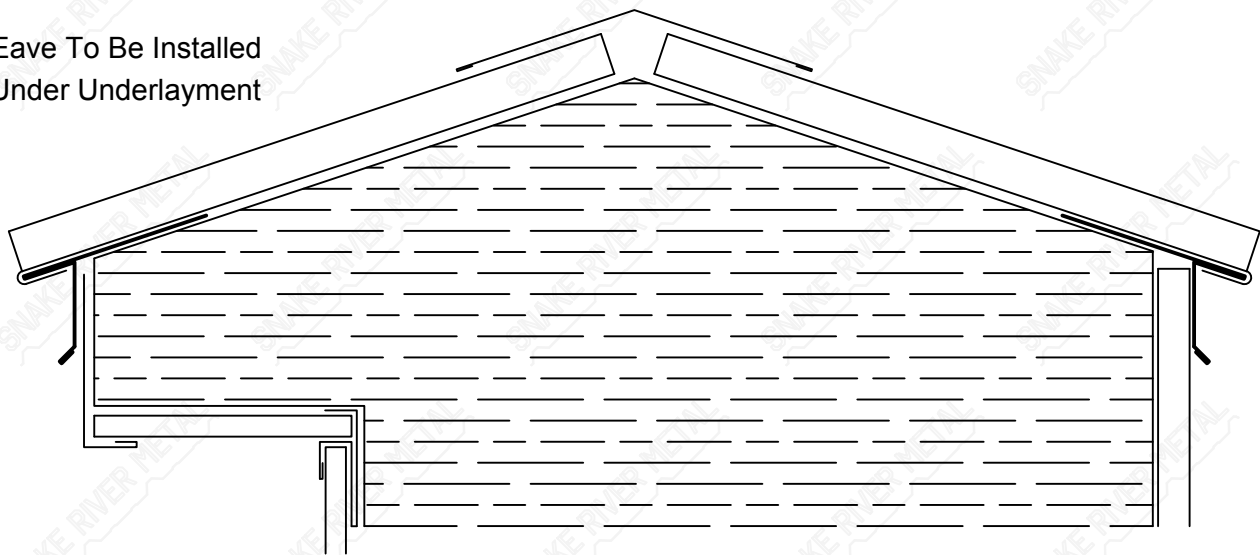

Modified Eave On Next Page

Return  
To Top

# Modified Eave - Flange Lock

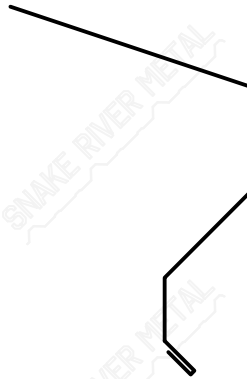

## Modified Eave

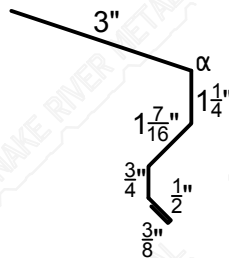

$\alpha$ : Specify Pitch Of Roof

Eave To Be Installed  
Under Underlayment

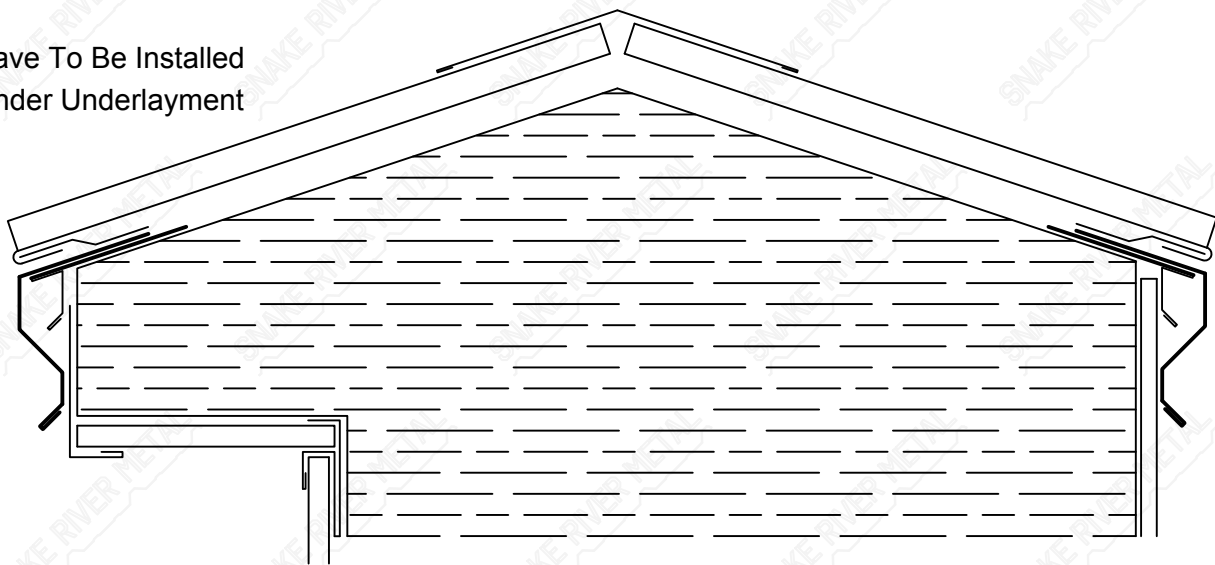

Panel Cleat On Next Page

Return  
To Top

# Panel Cleat - Flange Lock



## Panel Cleat

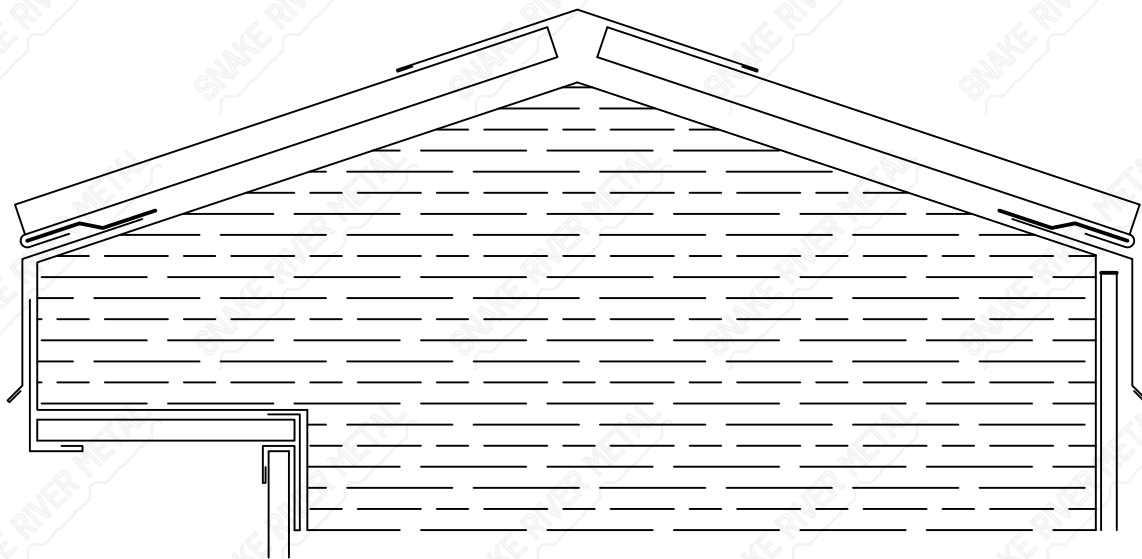
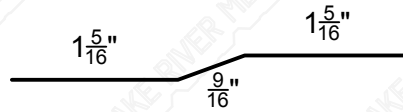

Fascia On Next Page

Return  
To Top

# Fascia - Flange Lock



Fascia ( 4" x 1  $\frac{1}{4}$ " )



Fascia ( 6" x 1  $\frac{1}{4}$ " )

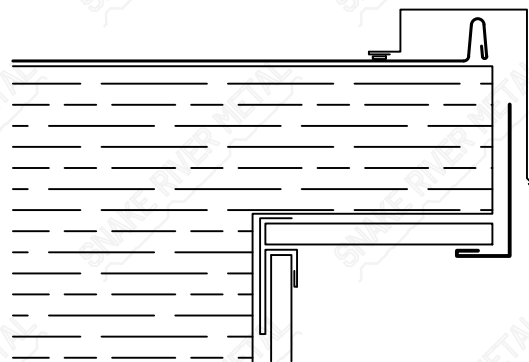
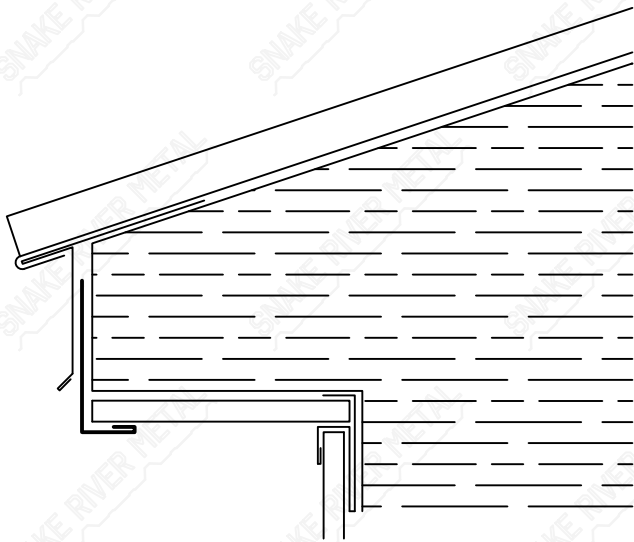
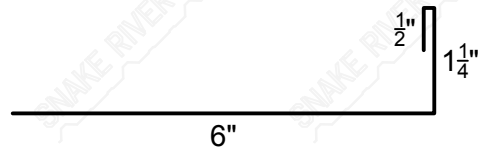

Gutter On Next Page



Return  
To Top

# Gutter - Flange Lock

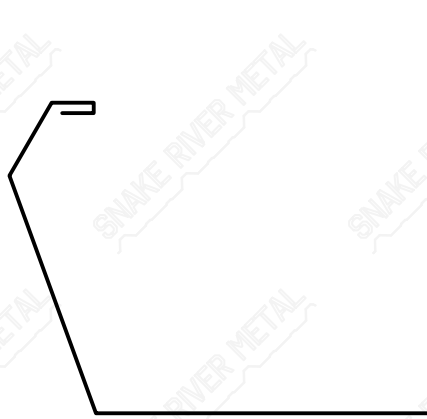

## Gutter

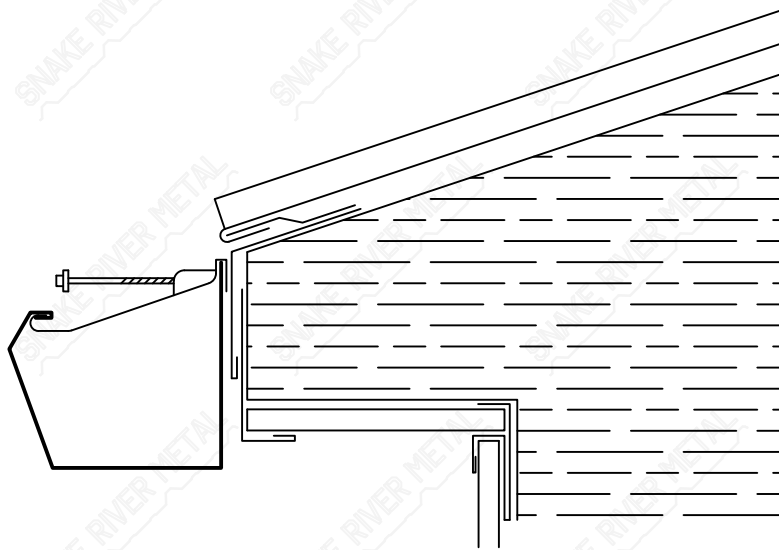
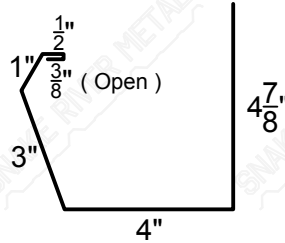

Down Spout On Next Page

Return  
To Top

# Down Spout - Flange Lock

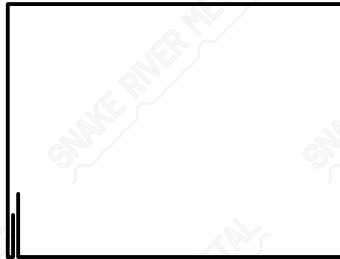

## Down Spout

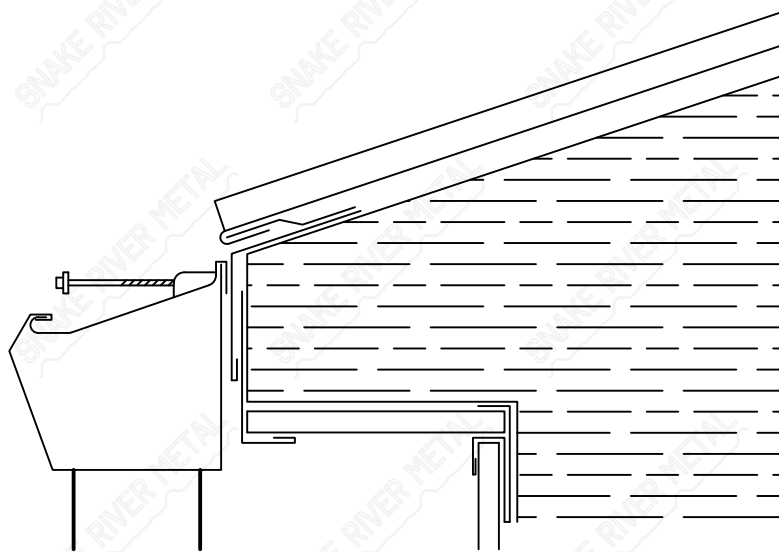
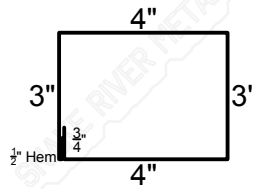

W Valley On Next Page

Return  
To Top

# W-Valley - Flange Lock



## W-Valley

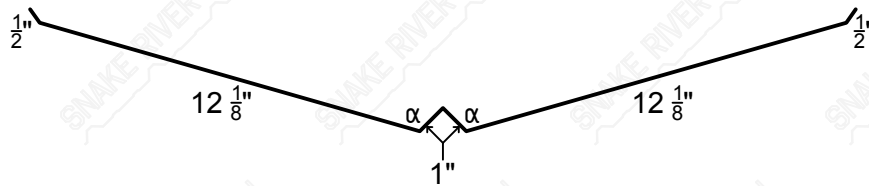

$\alpha$ : Specify Pitch Of Roof

Lap  
Sealant  
Recommended

Cut Panels 3" - 4"  
From Valley

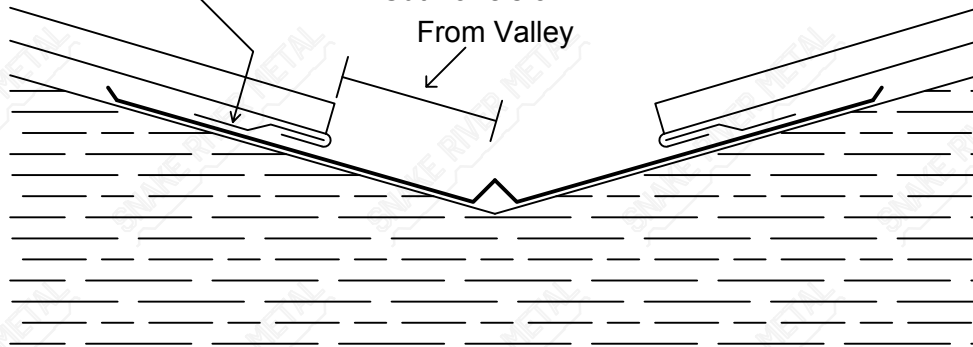

Chimney On Next Page

Return  
To Top

# Chimney Penetration

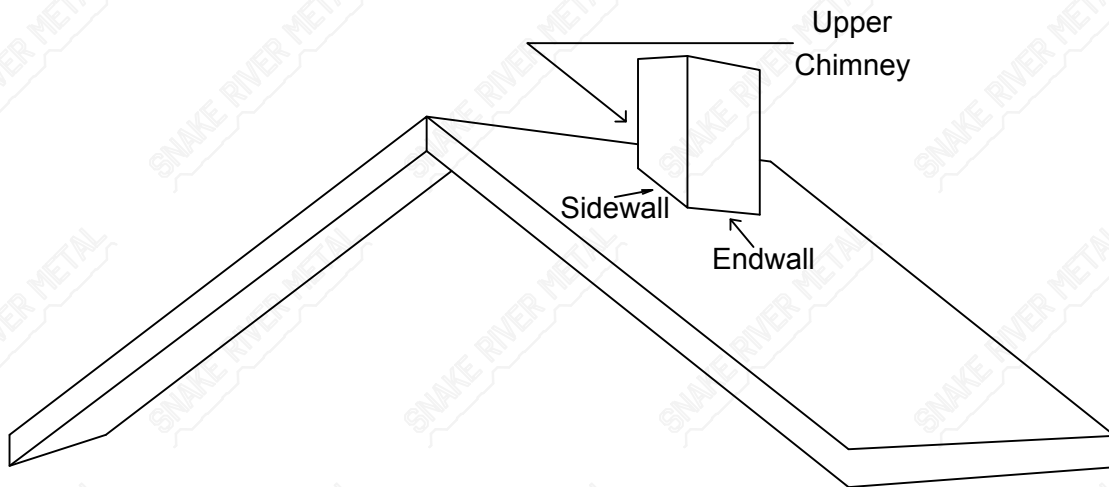

## Most Chimney's Include:

Upper Chimney

Endwall

Sidewall

Eave Cleat

Zee Closure

Upper Chimney On Next Page

Return  
To Top

# Upper Chimney - Flange Lock

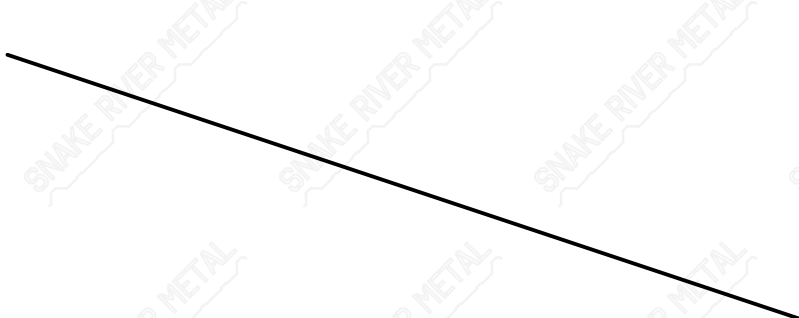

## Upper Chimney

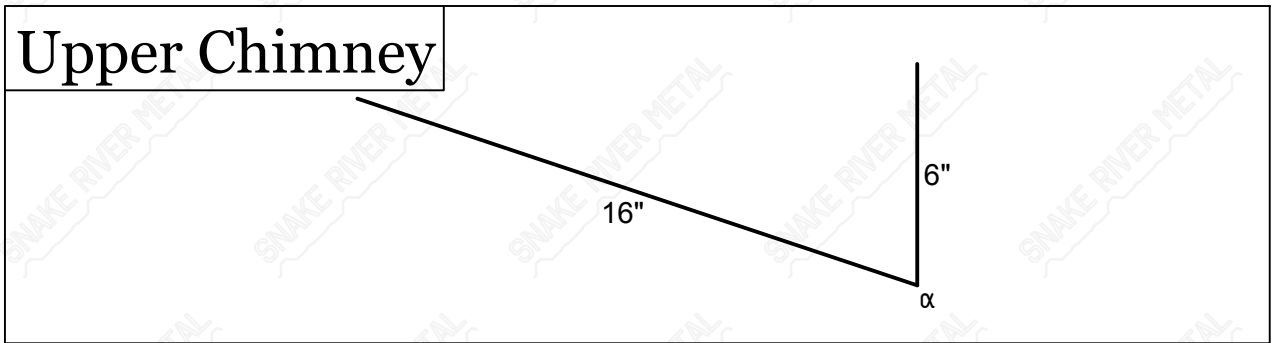

$\alpha$ : Specify Pitch Of Roof

Lap  
Sealant  
Recommended

Leave 2" - 3" Gap

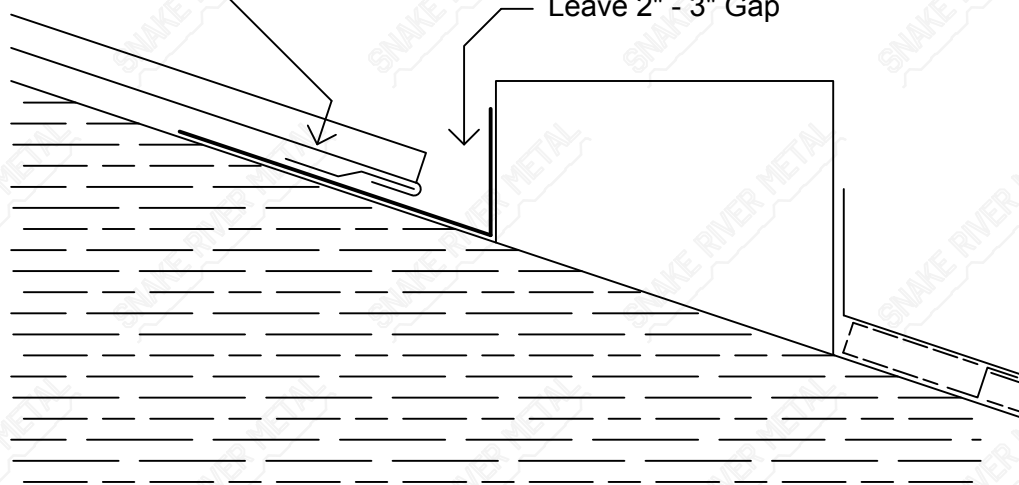

Endwall On Next Page

Return  
To Top

# Endwall - Flange Lock

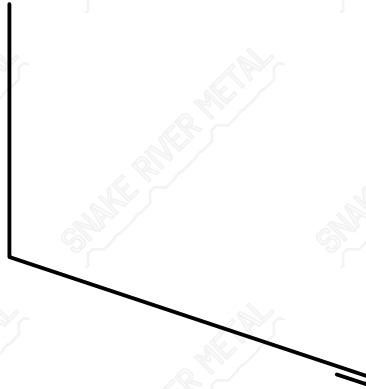

## Endwall

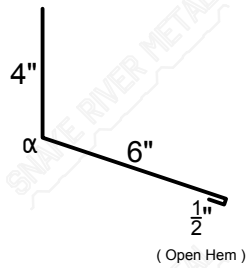

$\alpha$ : Specify Pitch Of Roof

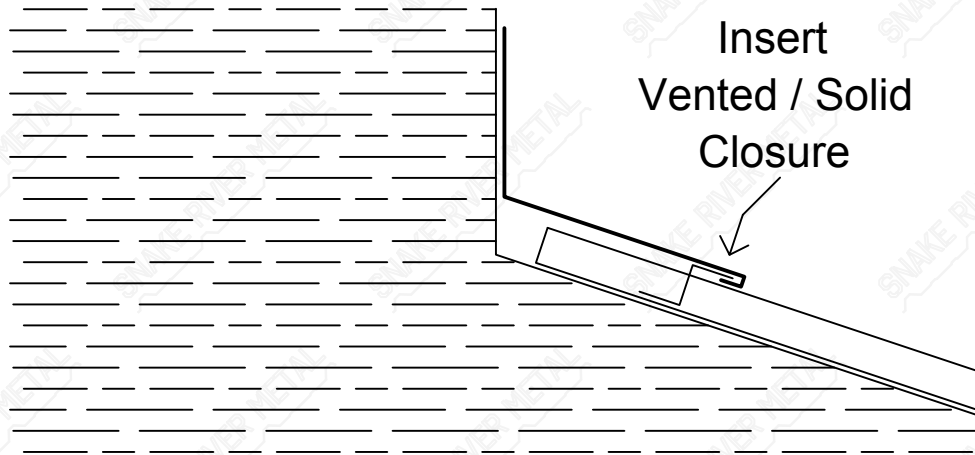

Sidewall On Next Page

Return  
To Top

# Sidewall - Flange Lock

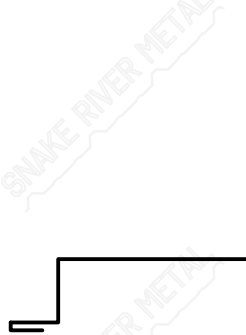

## Sidewall

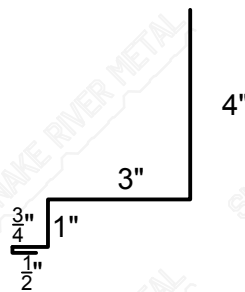

Laptape Sealant  
Recommended

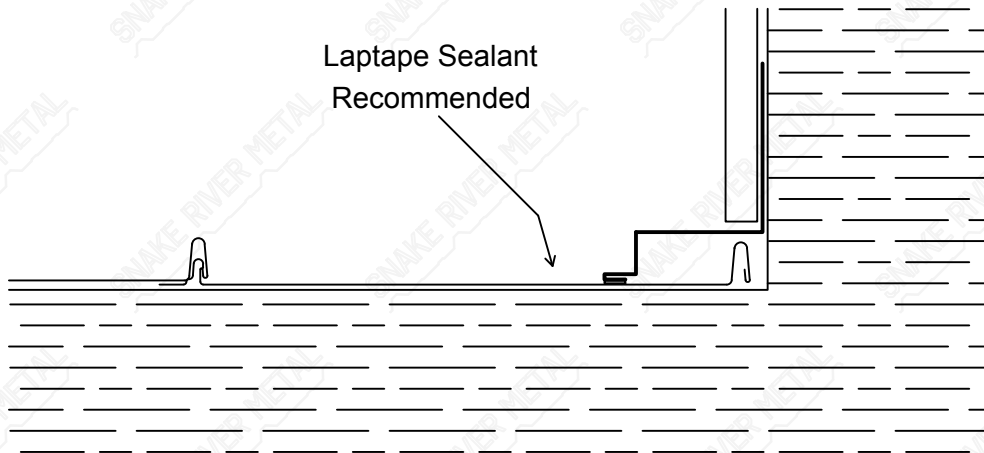

Transition On Next Page

Return  
To Top

# Transition - Flange Lock



## Transition

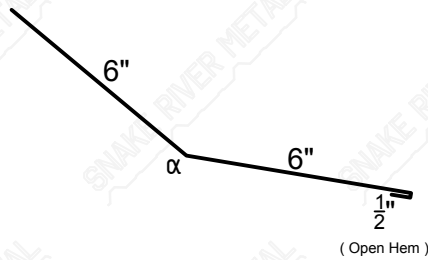

$\alpha$ : Specify Pitch Of Roof

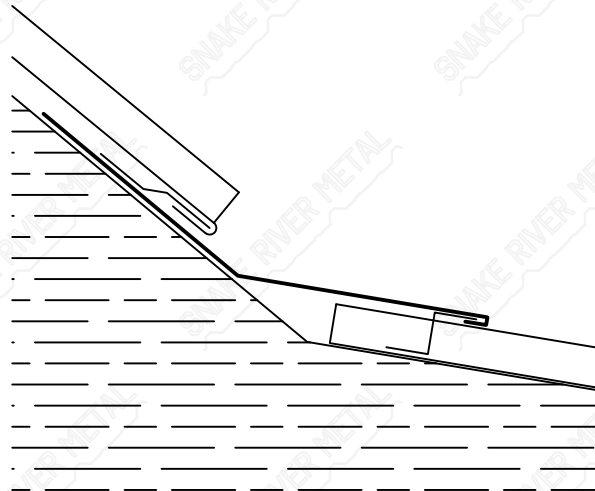

Gambrel On Next Page



Return  
To Top

# Gambrel - Flange Lock

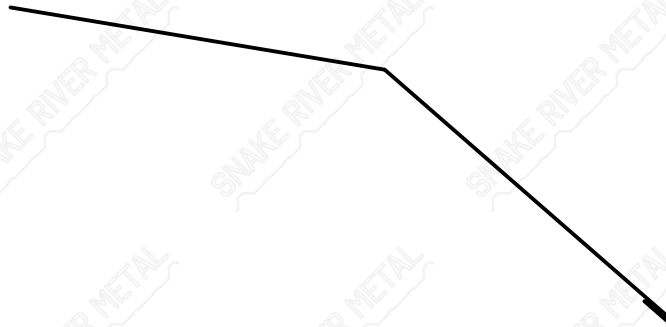

## Gambrel

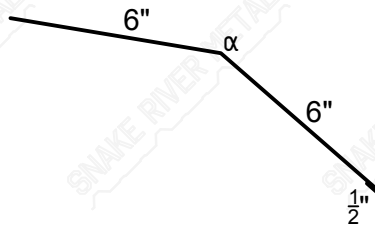

$\alpha$ : Specify Pitch Of Roof

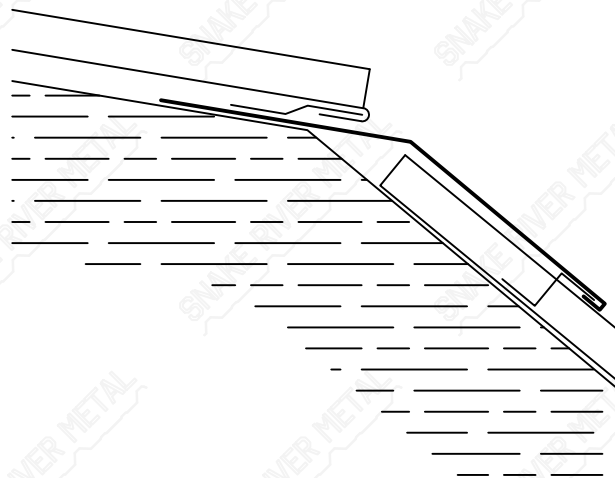

High Eave On Next Page

Return  
To Top

# High Eave - Flange Lock

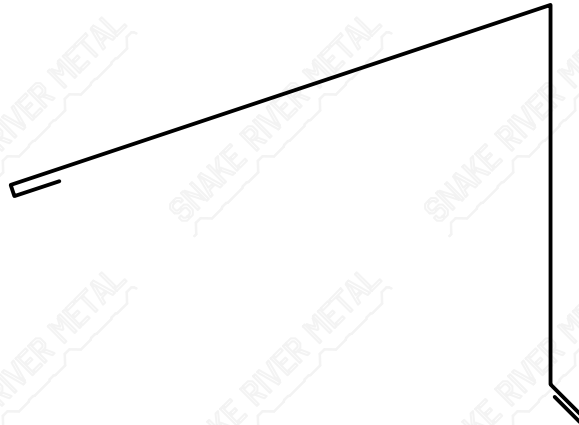

## High Eave

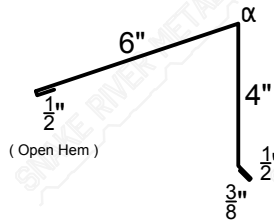

$\alpha$ : Specify Pitch Of Roof

