

# **SNAKE RIVER METAL**



## **STANDARD TRIM LIST SPARTAN PANEL**



# SNAKE RIVER METAL

## SPARTAN

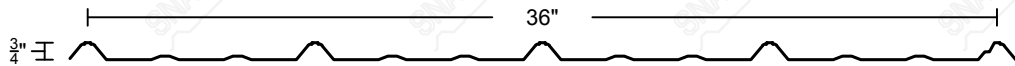

**FASTENERS: EXPOSED**

**COVERAGE: 36"**

**MINIMUM PITCH: 2.5:12**

**MINIMUM LENGTH: 33"**

**MAXIMUM LENGTH: 40'**

**MATERIAL THICKNESS: 29G**

**FINISH: 40 YEAR SMP**

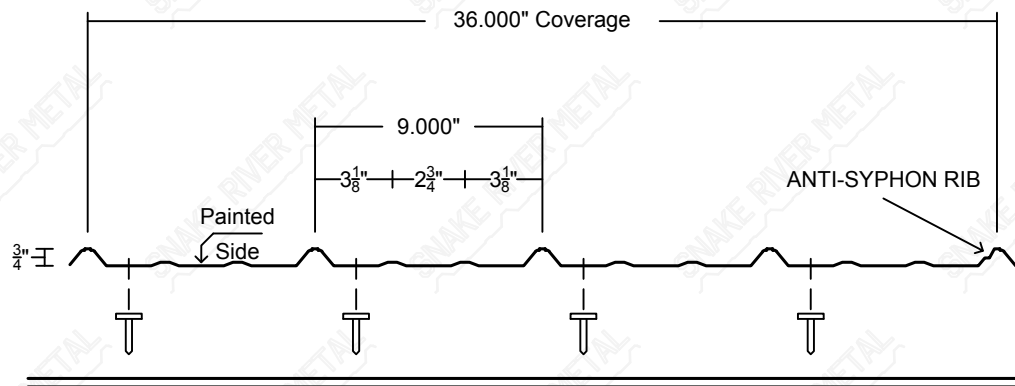
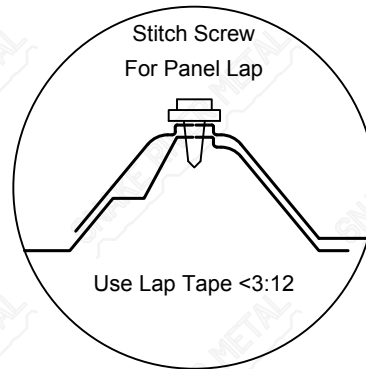

# Common Building Geometries

( Click On Building That Best Matches Your Projects Geometry )

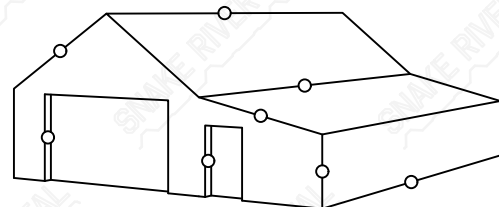
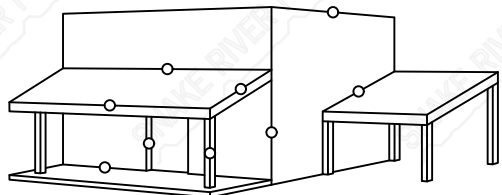
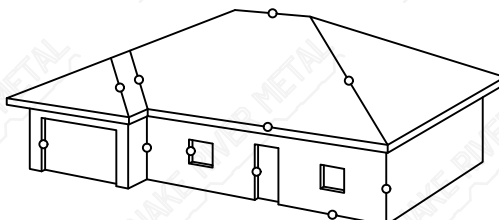
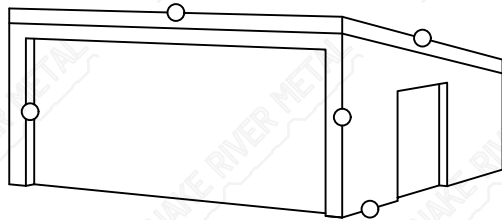
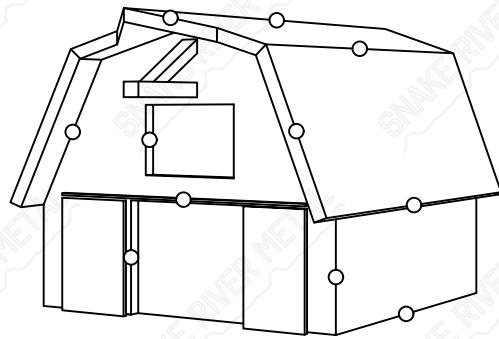
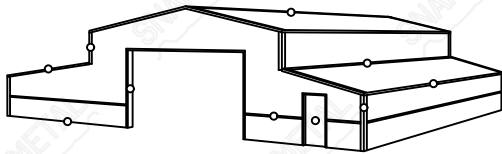
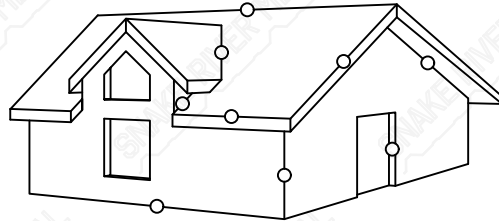
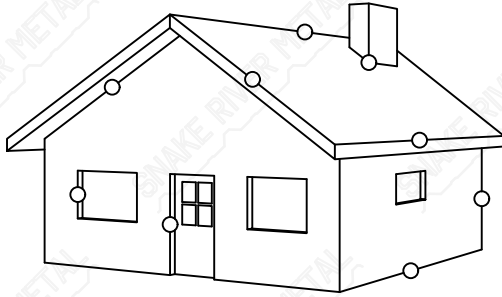

Gable Building Geometry On Next Page

Return  
To Top

# Gable Building Geometry

( Click On Circle That Best Matches Trim Location )

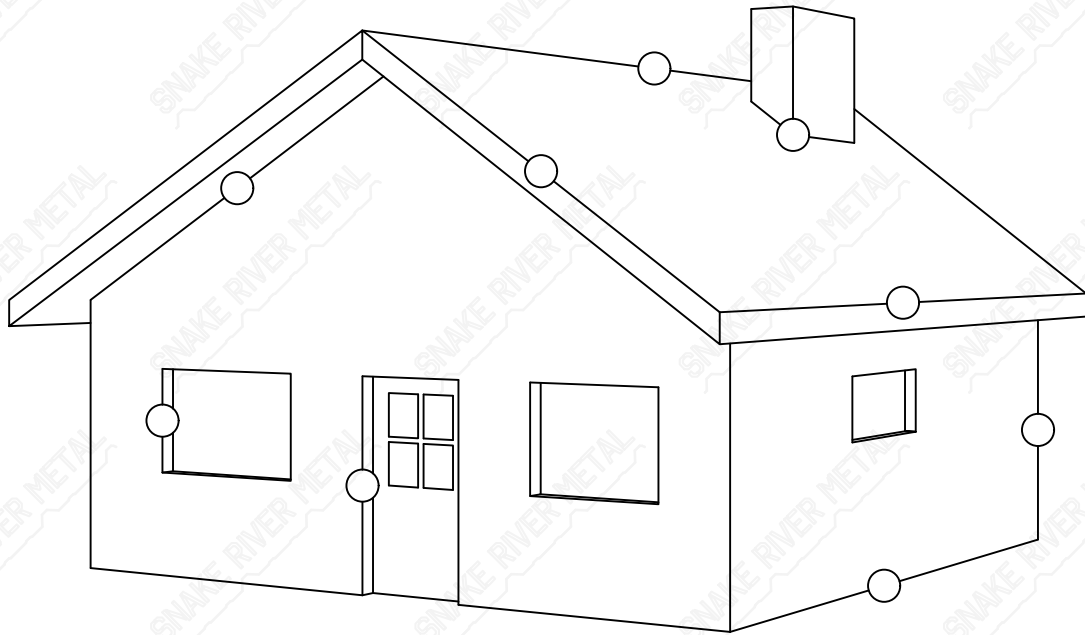

Dormer Building Geometry On Next Page

Return  
To Top

# Dormer Building Geometry

( Click On Circle That Best Matches Trim Location )

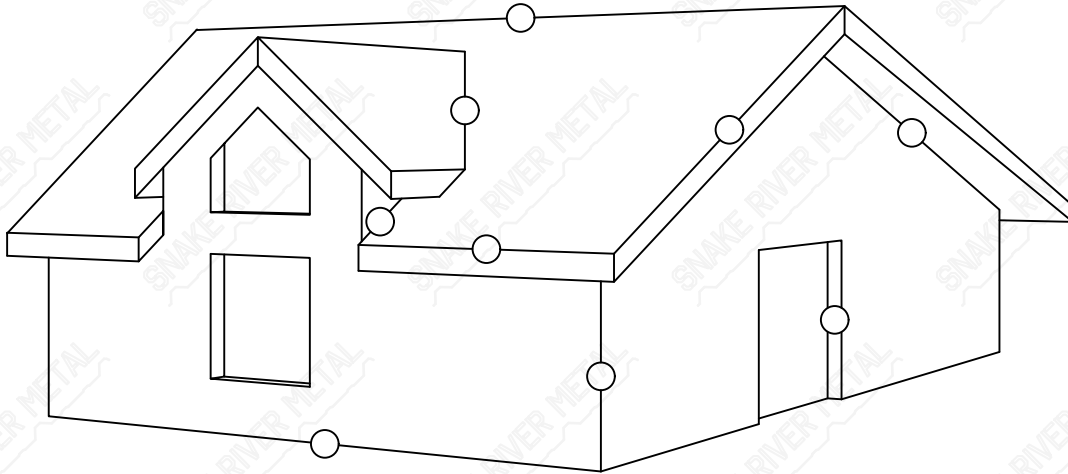

American Barn Geometry On Next Page

Return  
To Top

# American Barn Geometry

( Click On Circle That Best Matches Trim Location )

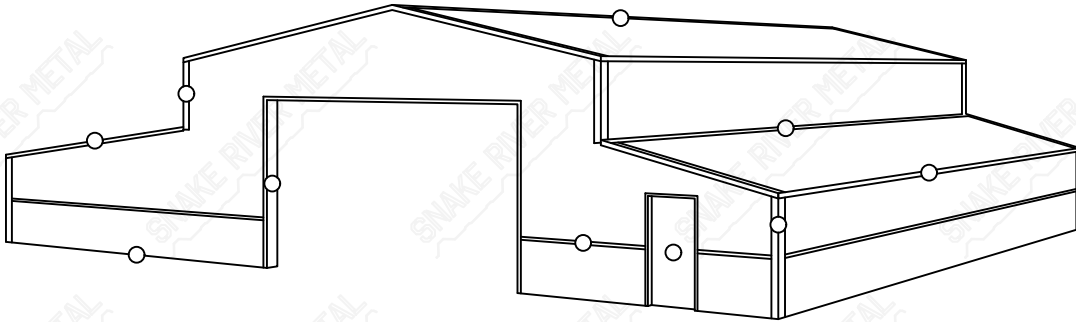

Gambrel Building Geometry On Next Page

Return  
To Top

# Gambrel Building Geometry

( Click On Circle That Best Matches Trim Location )

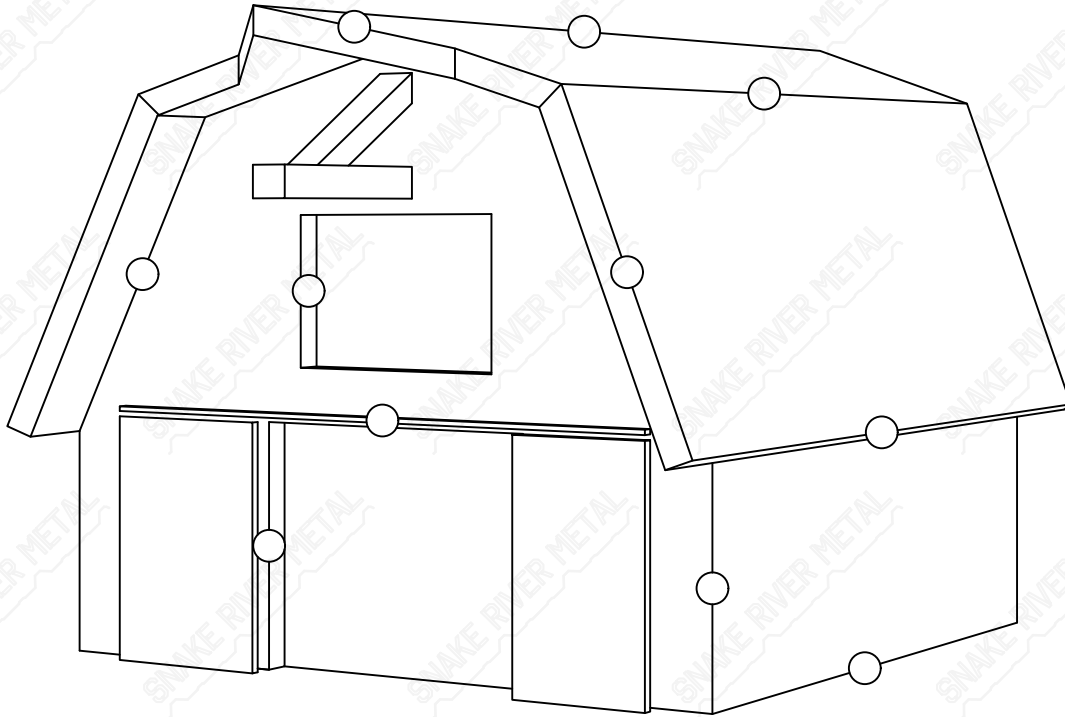

Single Slope Shed Geometry On Next Page

Return  
To Top

# Single Slope Shed Geometry

( Click On Circle That Best Matches Trim Location )

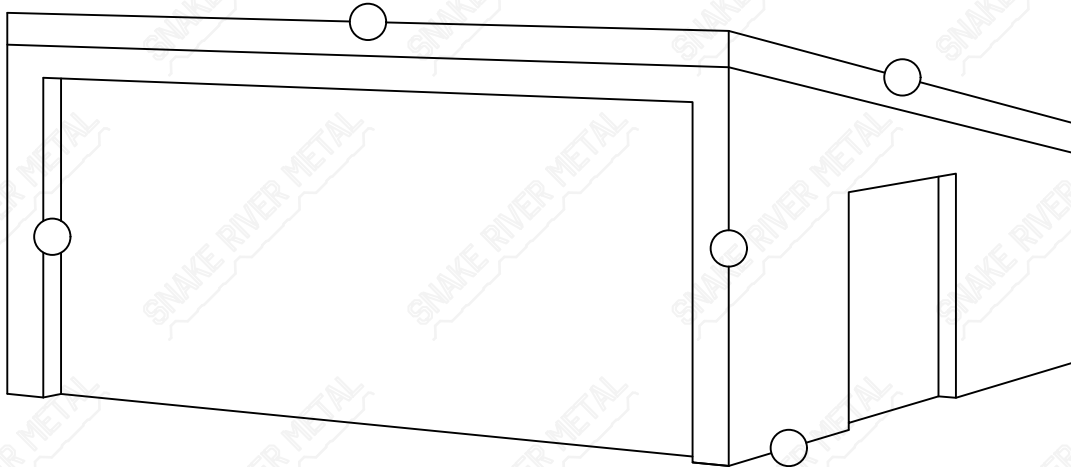

Hip Roof Geometry On Next Page



Return  
To Top

# Hip Roof Geometry

( Click On Circle That Best Matches Trim Location )

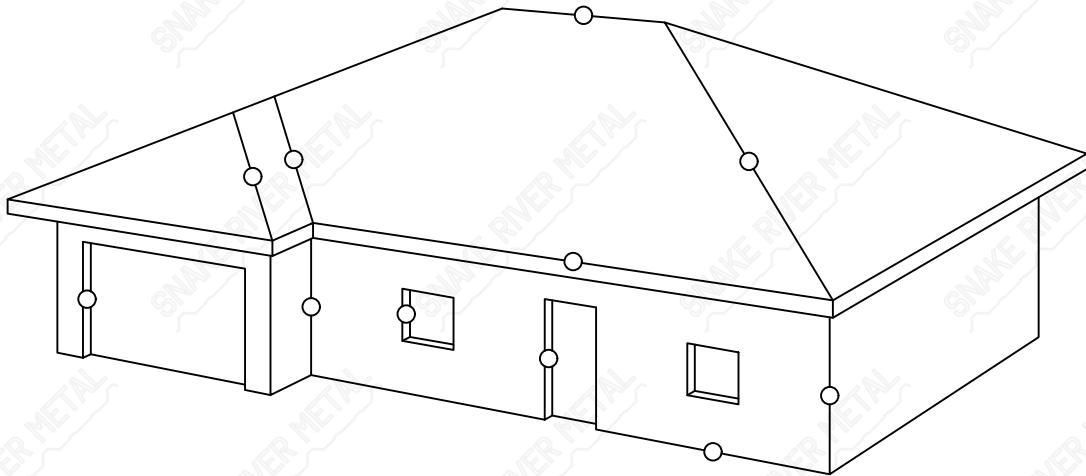

Leanto Building Geometry On Next Page

Return  
To Top

# Leanto Building Geometry

( Click On Circle That Best Matches Trim Location )

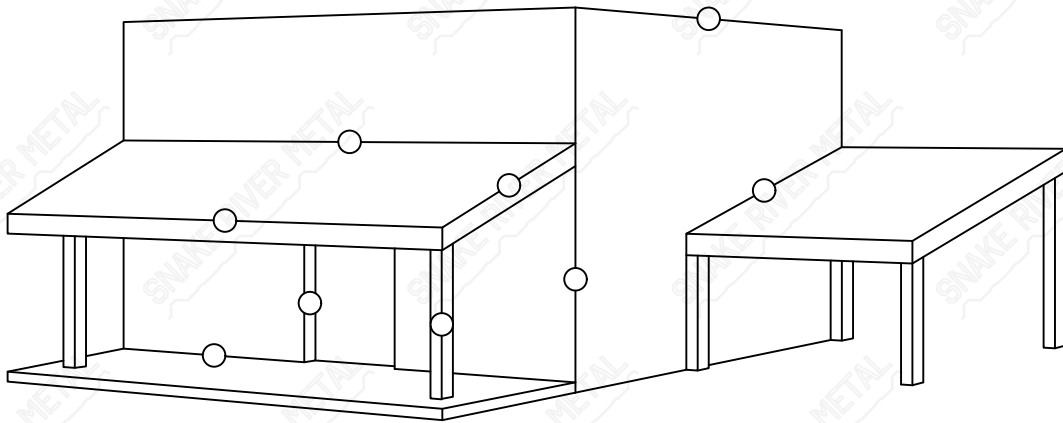

Transition Building Geometry On Next Page

Return  
To Top

# Transition Building Geometry

( Click On Circle That Best Matches Trim Location )

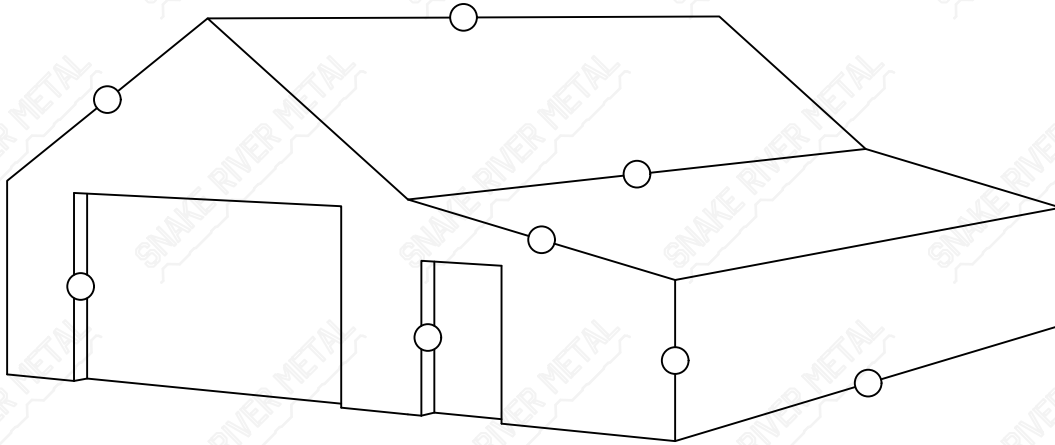

Ridge Cap On Next Page

Return  
To Top

# Ridge Cap - Spartan

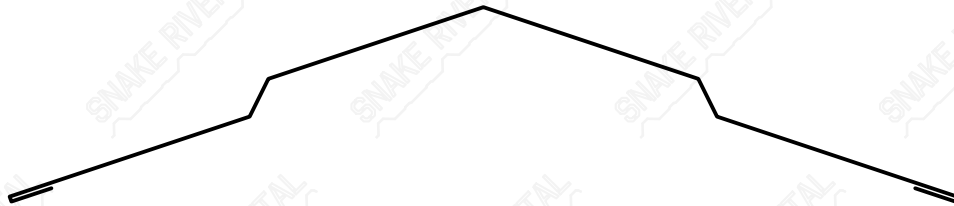

## Ridge

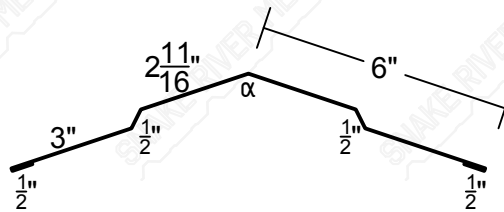

$\alpha$ : Specify Pitch Of Roof

For Vented Systems:  
Cut Substrate And Panel

Back 1 1/2" To 2"

Insert  
Vented / Solid  
Closure

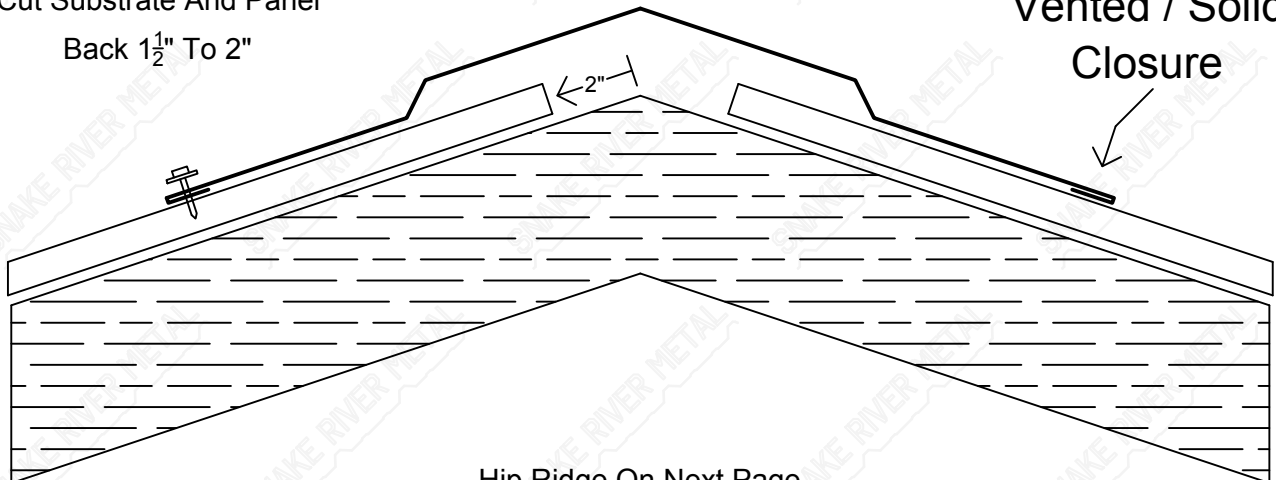

Hip Ridge On Next Page

Return  
To Top

# Hip Ridge - Spartan

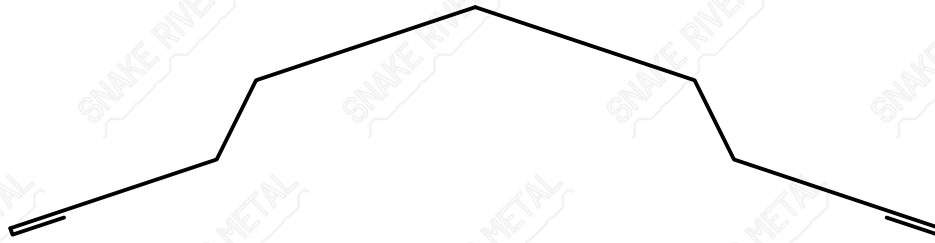

## Hip Ridge

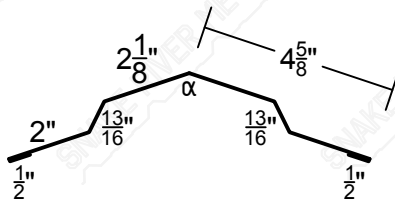

$\alpha$ : Specify Pitch Of Roof

For Vented Systems:  
Cut Substrate And Panel

Back 1 1/2" To 2"

Insert  
Vented / Solid  
Closure

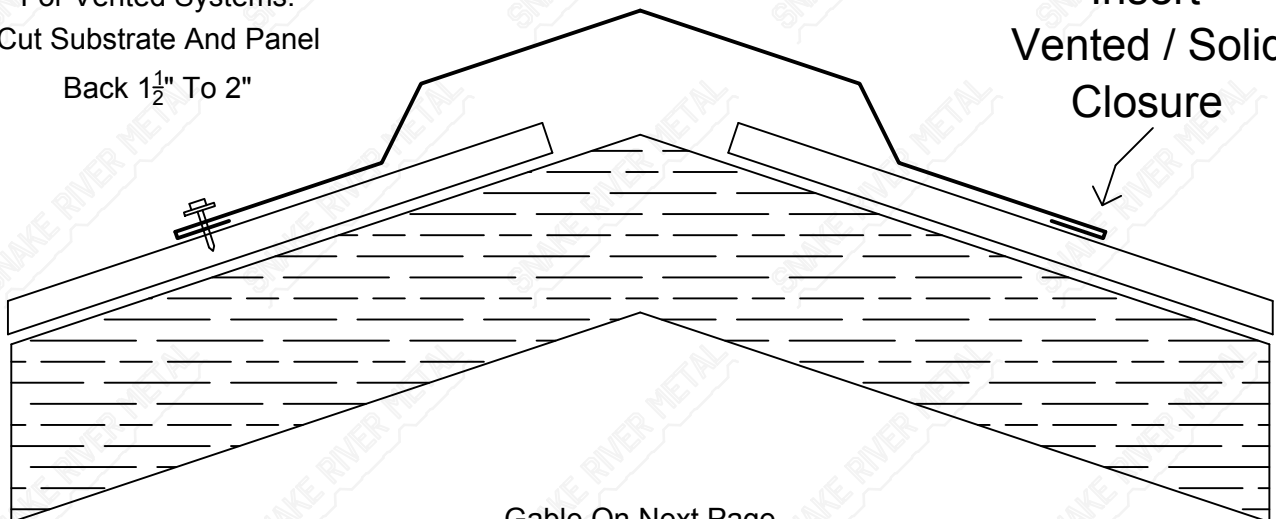

Gable On Next Page

Return  
To Top

# Gable - Spartan

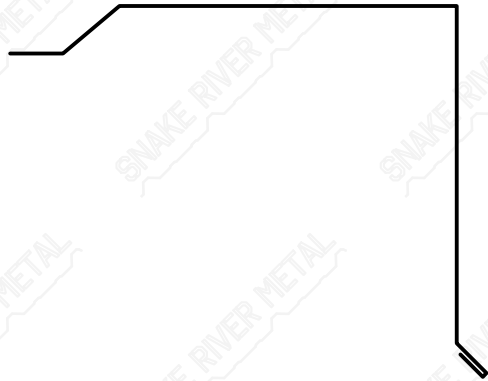

## Gable

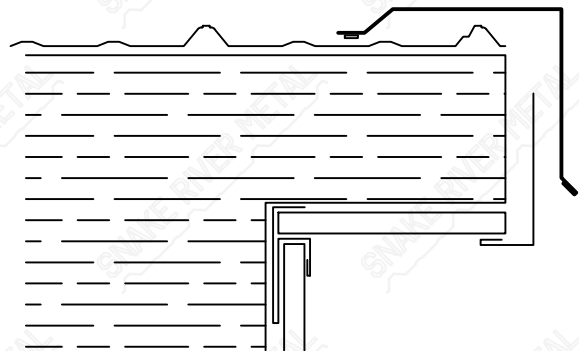
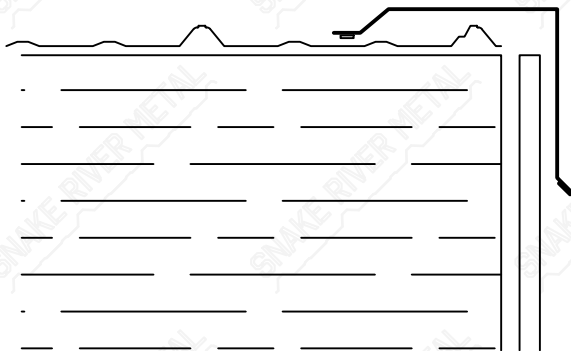
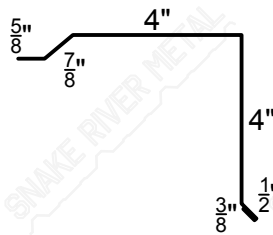

Mini Gable On Next Page

Return  
To Top

# Mini Gable - Spartan

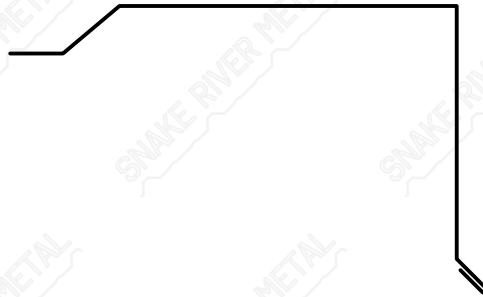

## Mini Gable

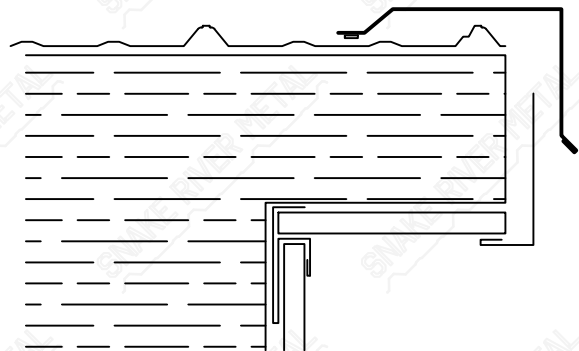
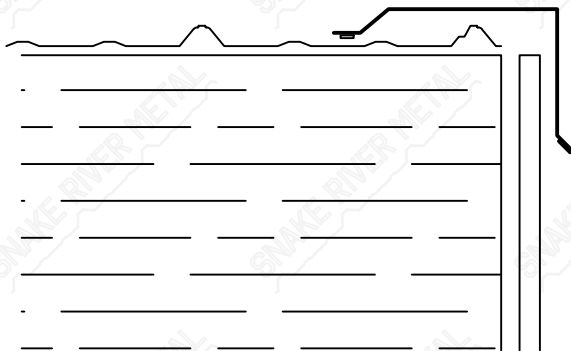
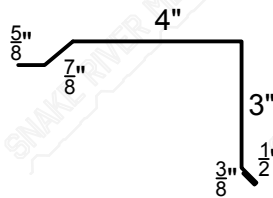

Modified Gable On Next Page

Return  
To Top

# Modified Gable - Spartan

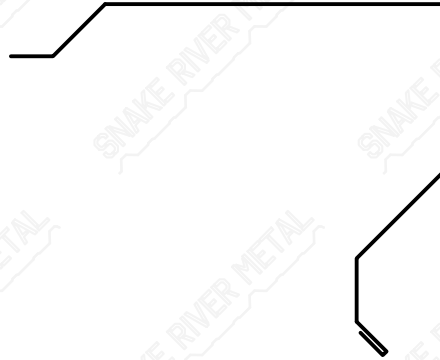

## Modified Gable

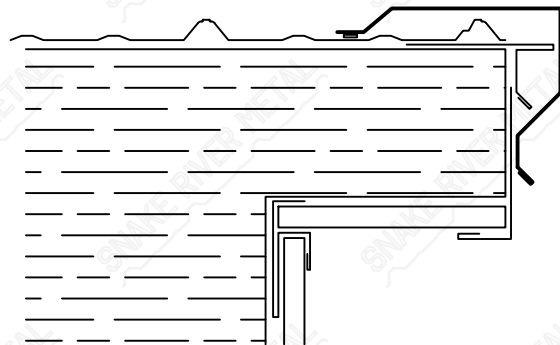
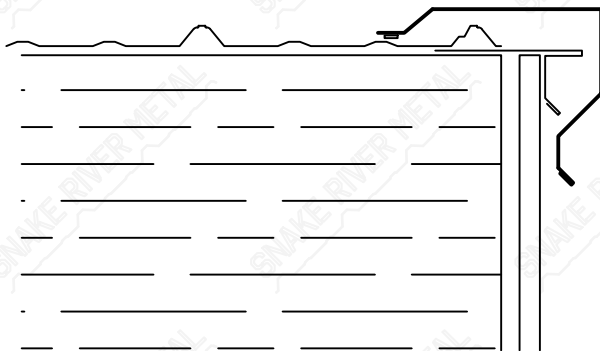
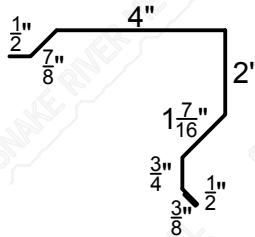

Swept Wing Gable On Next Page



Return  
To Top

# Swept Wing Gable - Spartan



## Swept Wing Gable

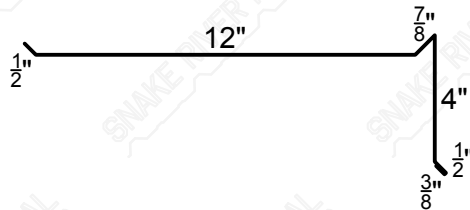

Laptape Sealant  
Recommended

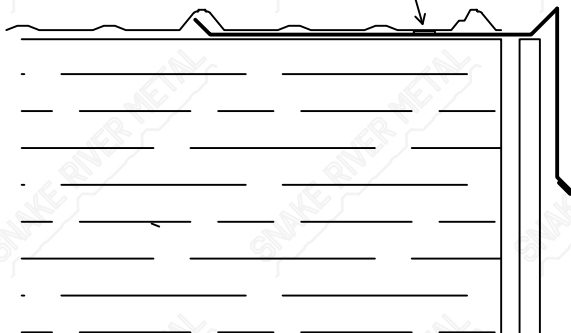

Laptape Sealant  
Recommended

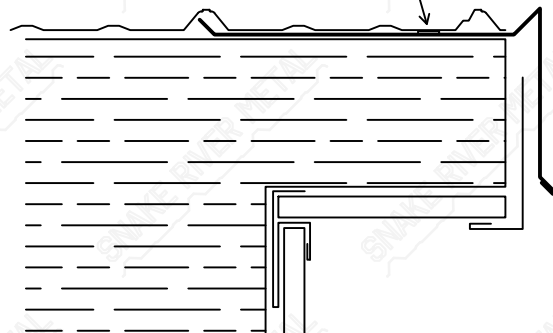

Fascia On Next Page

Return  
To Top

# Fascia - Spartan



Fascia ( 4" x 1  $\frac{1}{4}$ " )

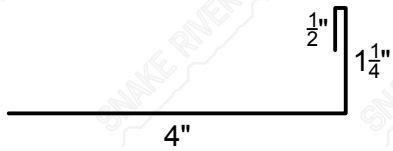

Fascia ( 6" x 1  $\frac{1}{4}$ " )

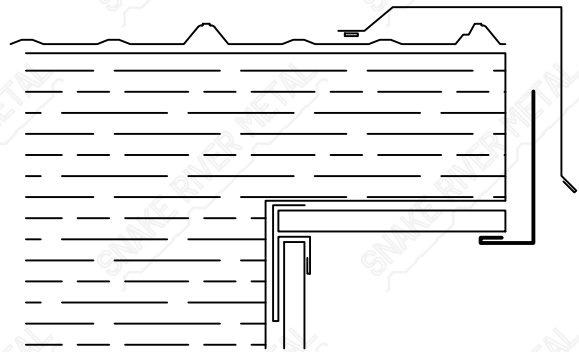
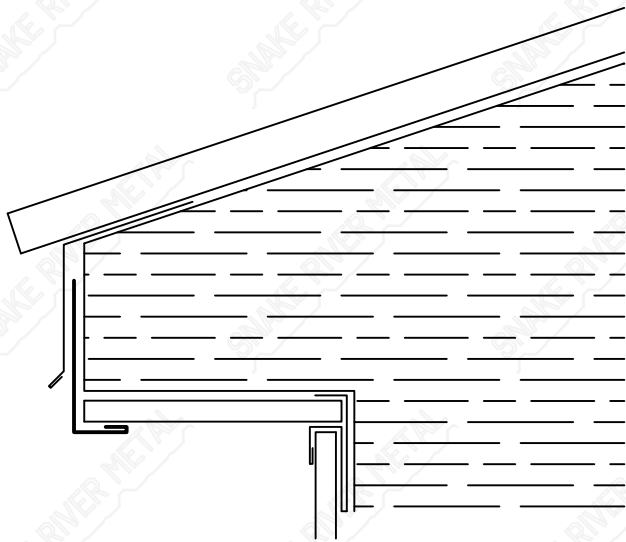
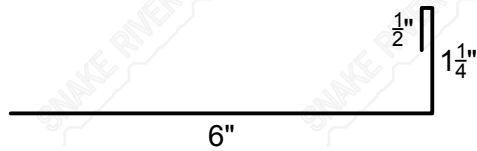

"F" Channel On Next Page

Return  
To Top

# "F" Channel - Spartan

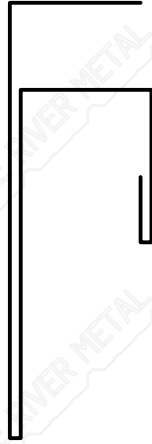

"F" Channel (  $\frac{1}{2}$ " x  $\frac{3}{4}$ " )

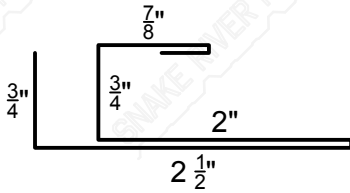

"F" Channel (  $\frac{3}{4}$ " x  $\frac{3}{4}$ " )

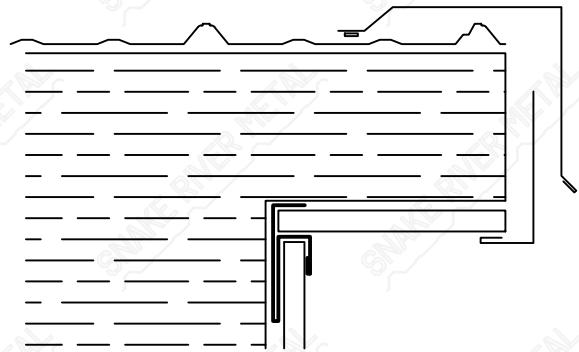
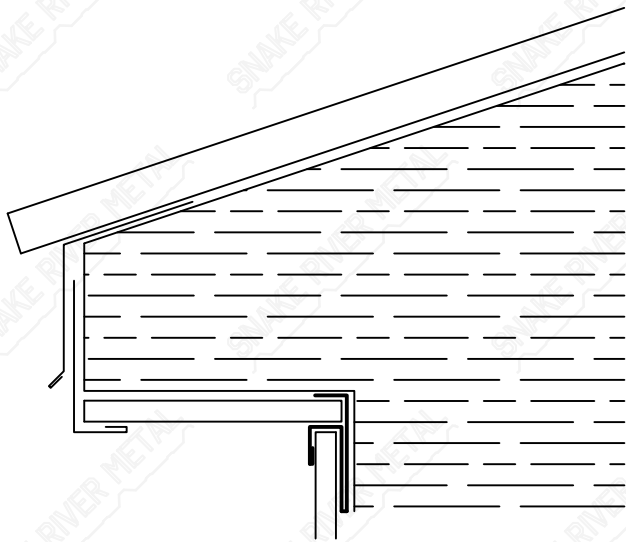
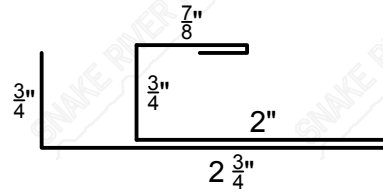

"F" Channel Continued On Next Page

Return  
To Top

# "F" Channel - Spartan

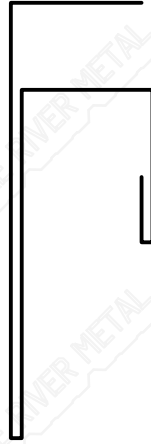

"F" Channel ( 1" x  $\frac{3}{4}$ " )

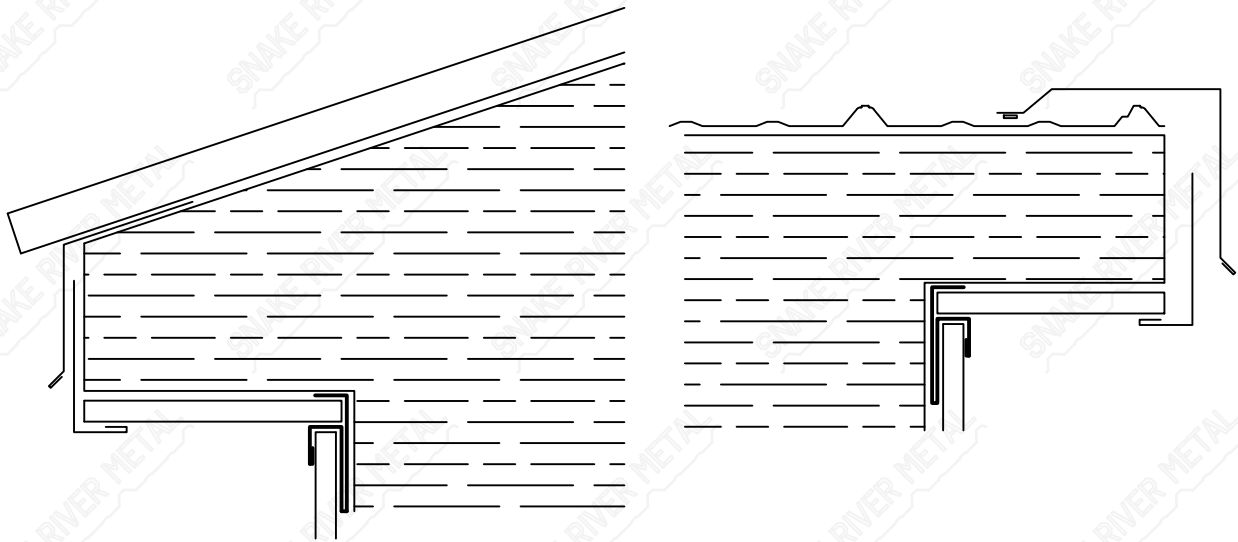
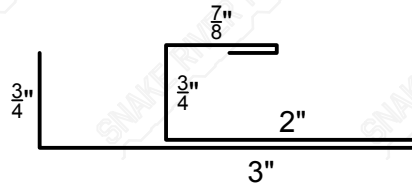

Eave On Next Page

Return  
To Top

# Eave - Spartan

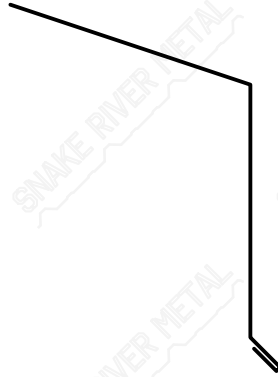

Eave

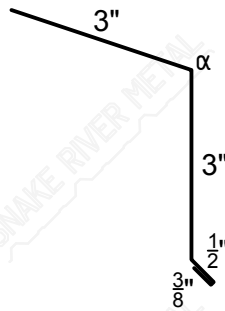

$\alpha$ : Specify Pitch Of Roof

Eave To Be Installed  
Under Underlayment

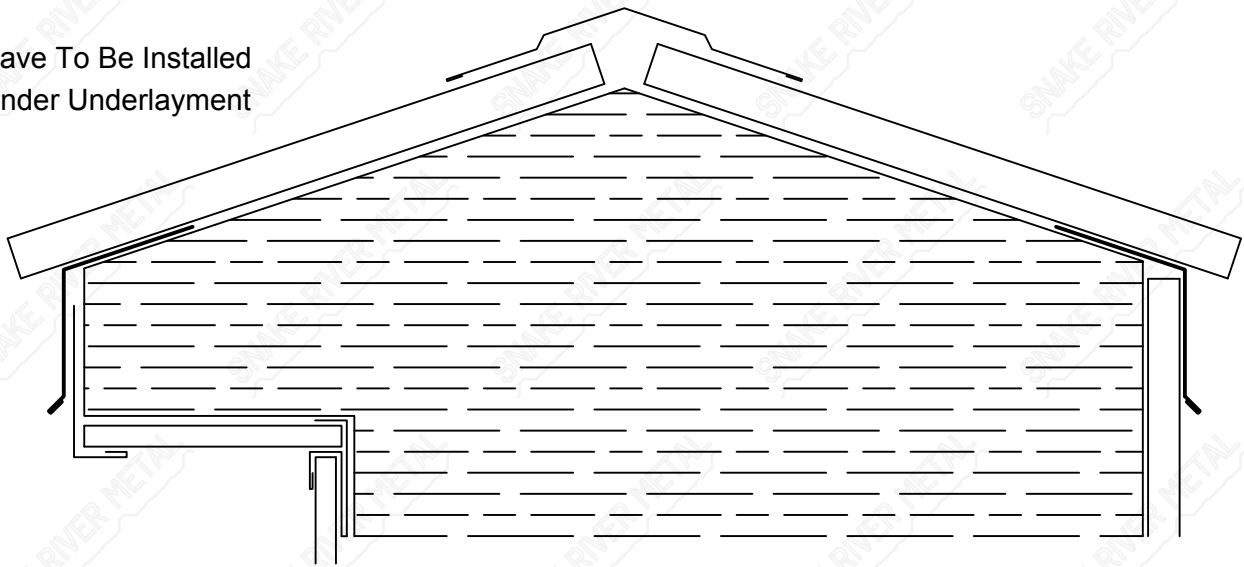

Mini Eave On Next Page

Return  
To Top

# Mini Eave - Spartan

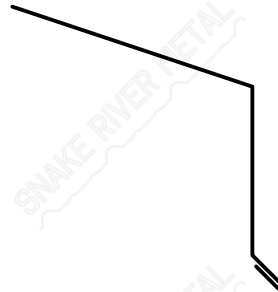

## Mini Eave

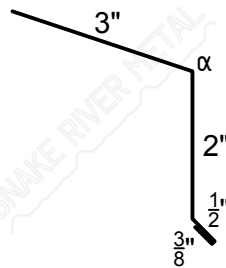

$\alpha$ : Specify Pitch Of Roof

Eave To Be Installed  
Under Underlayment

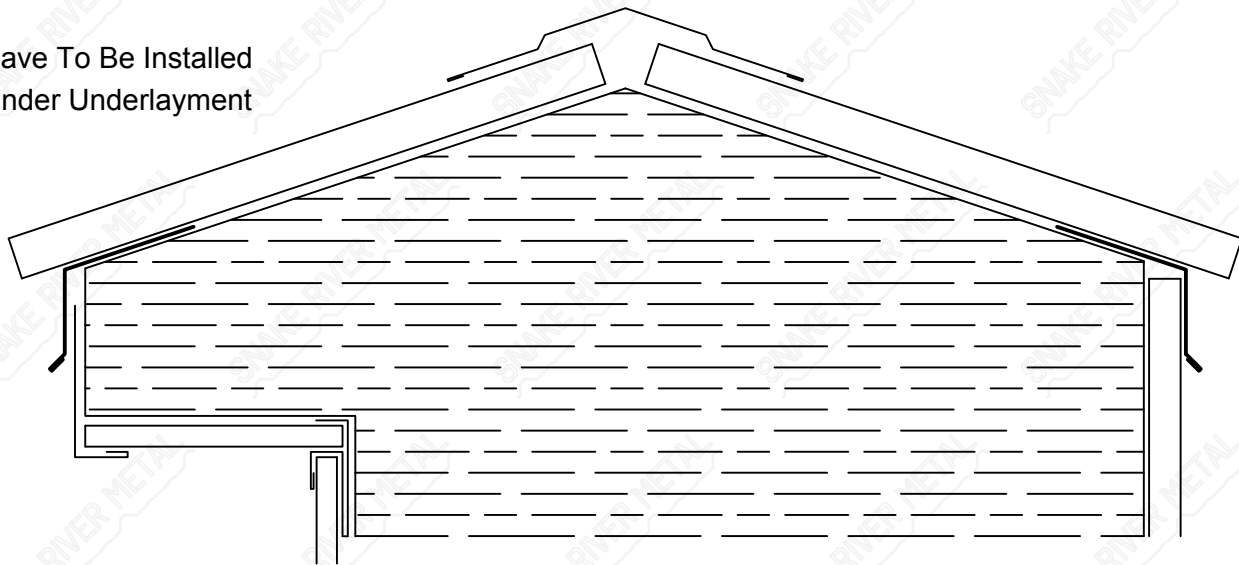

Modified Eave On Next Page

Return  
To Top

# Modified Eave - Spartan

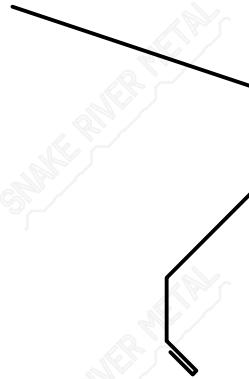

## Modified Eave

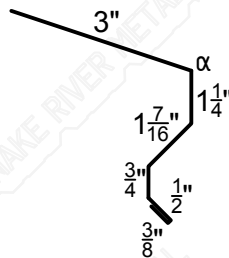

$\alpha$ : Specify Pitch Of Roof

Eave To Be Installed  
Under Underlayment

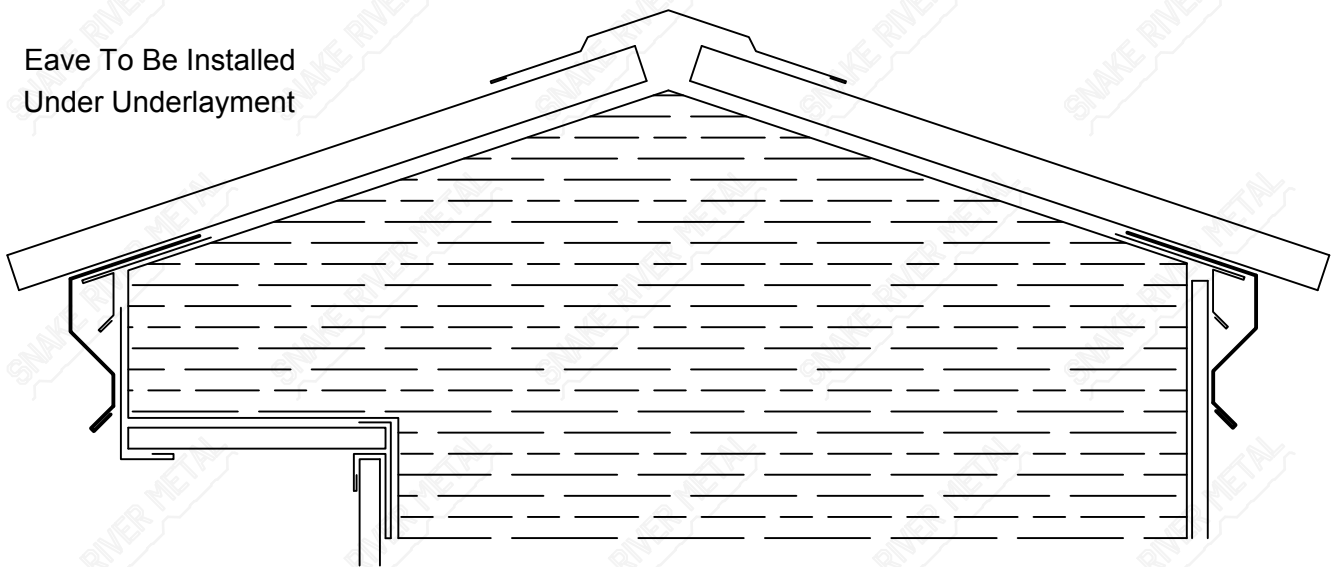

Fascia On Next Page

Return  
To Top

# Fascia - Spartan



Fascia ( 4" x 1  $\frac{1}{4}$ " )

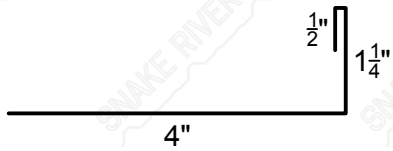

Fascia ( 6" x 1  $\frac{1}{4}$ " )

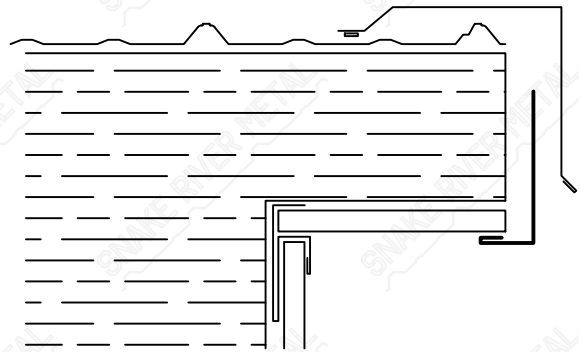
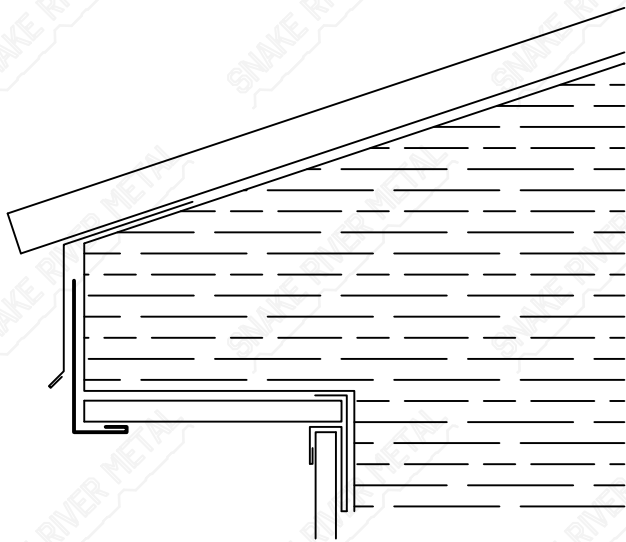
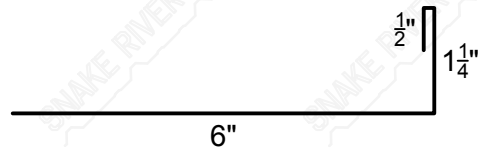

"F" Channel On Next Page



Return  
To Top

# "F" Channel - Spartan

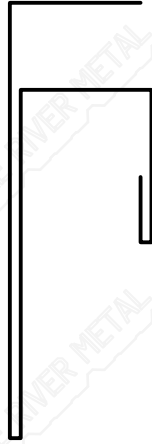

"F" Channel (  $\frac{1}{2}$ " x  $\frac{3}{4}$ " )

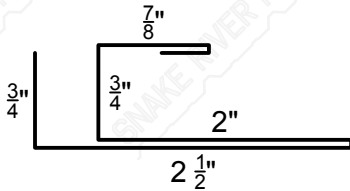

"F" Channel (  $\frac{3}{4}$ " x  $\frac{3}{4}$ " )

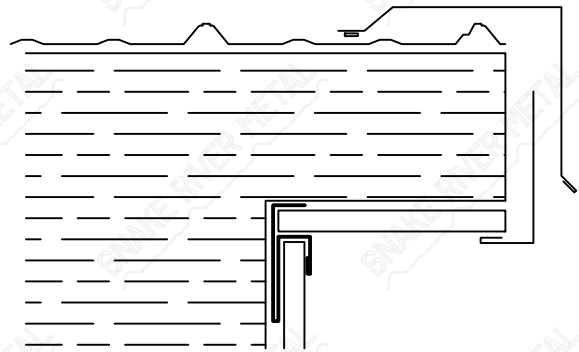
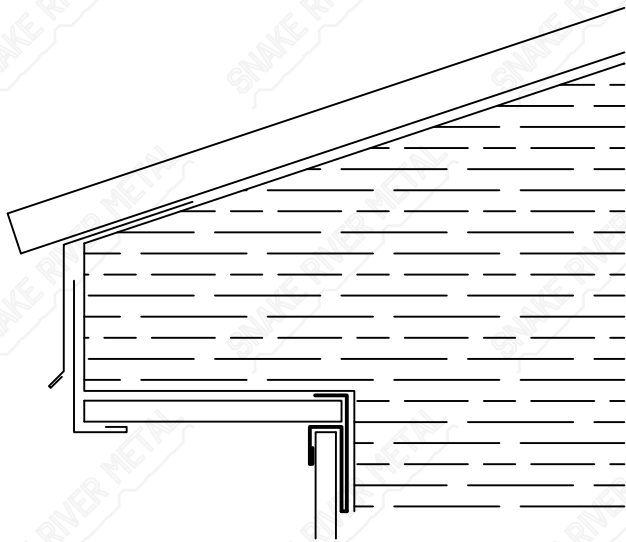
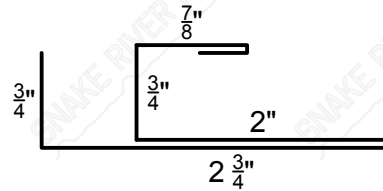

"F" Channel Continued On Next Page

Return  
To Top

# "F" Channel - Spartan

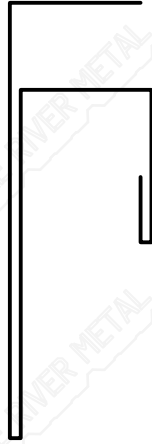

"F" Channel ( 1" x  $\frac{3}{4}$ " )

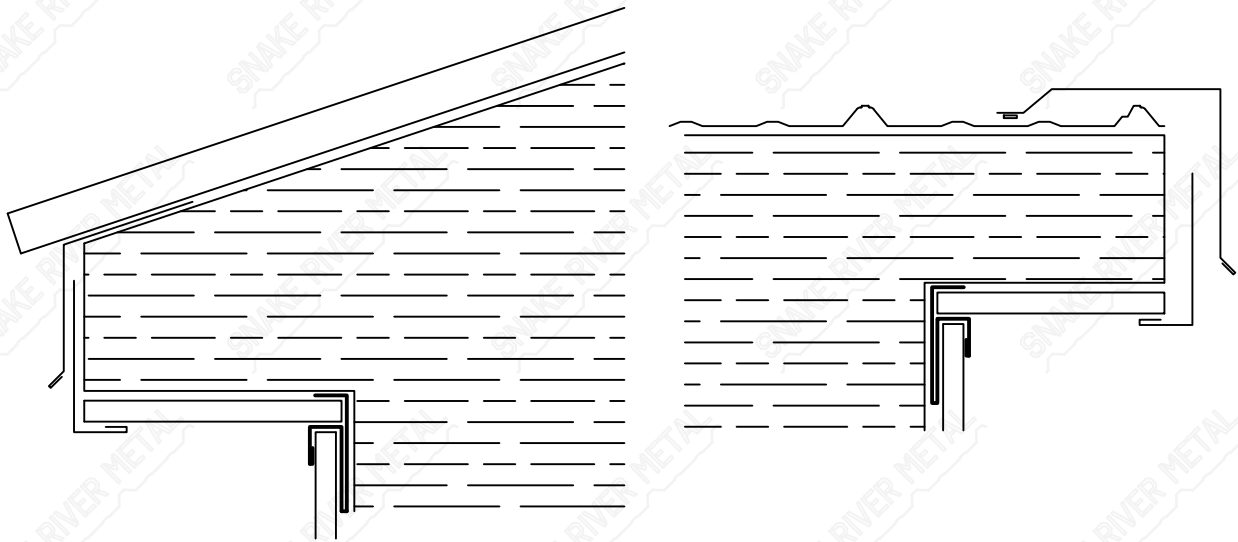
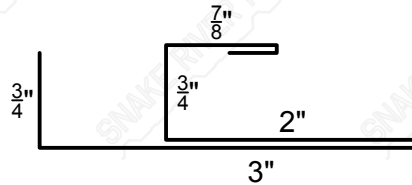

Gutter On Next Page

Return  
To Top

# Gutter - Spartan

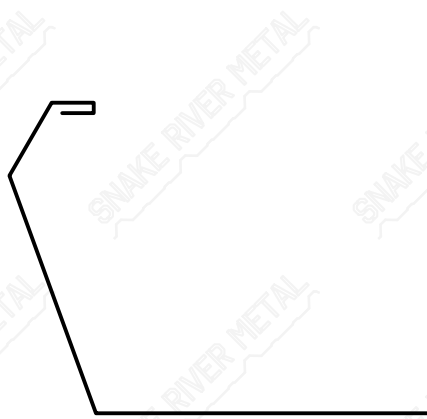

## Gutter

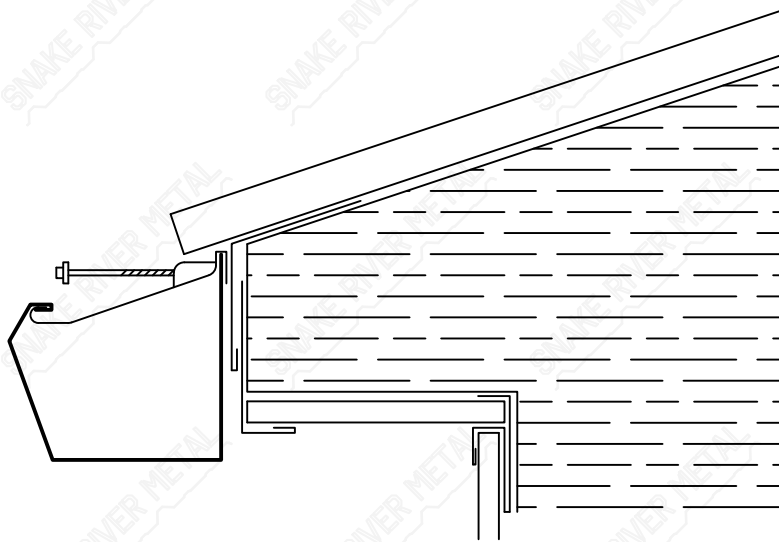
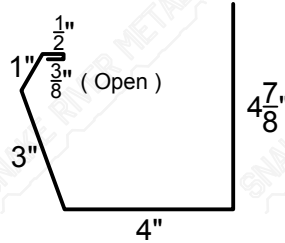

Down Spout On Next Page

Return  
To Top

# Down Spout - Spartan

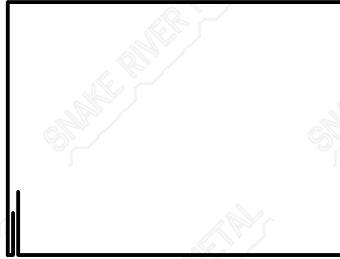

## Down Spout

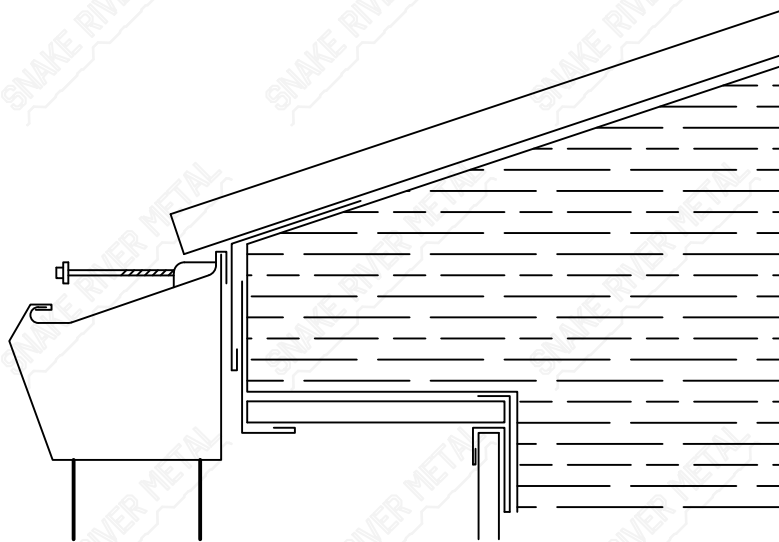
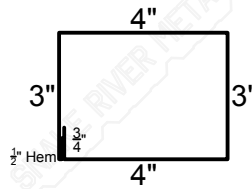

Snow Stop On Next Page

Return  
To Top

# Snow Stop - Spartan

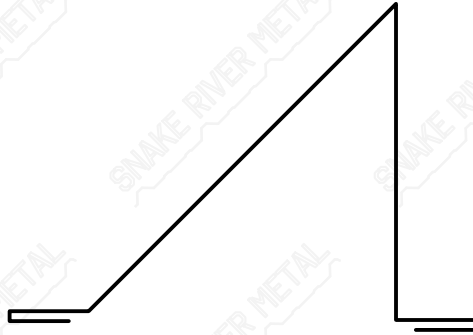

## Snow Stop

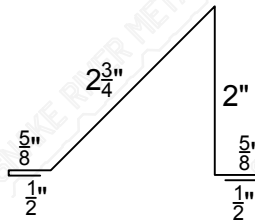

Secure Attachment To  
Trusses And Substructure

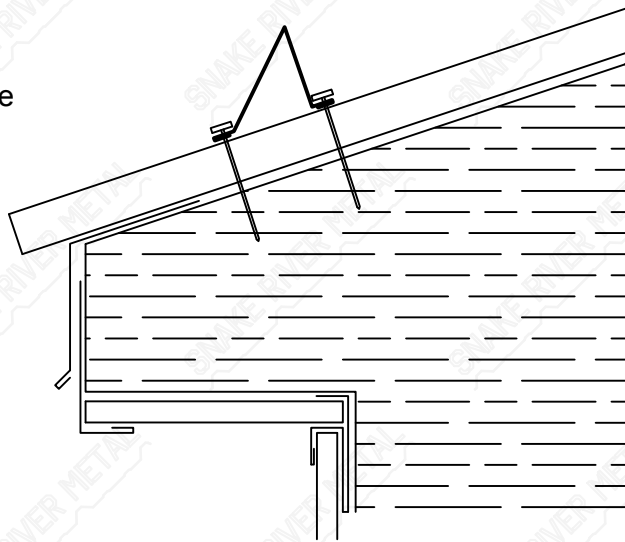

W-Valley On Next Page

Return  
To Top

# W-Valley - Spartan

## W-Valley

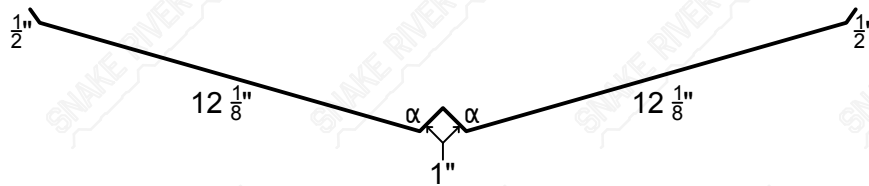

$\alpha$ : Specify Pitch Of Roof

Laptape Sealant  
Recommended

Cut Panels 3" - 4"  
From Valley

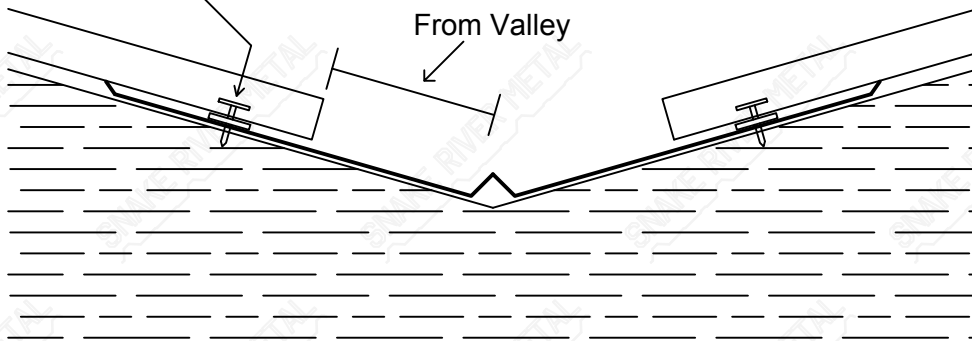

Chimney On Next Page

Return  
To Top

# Chimney Penetration

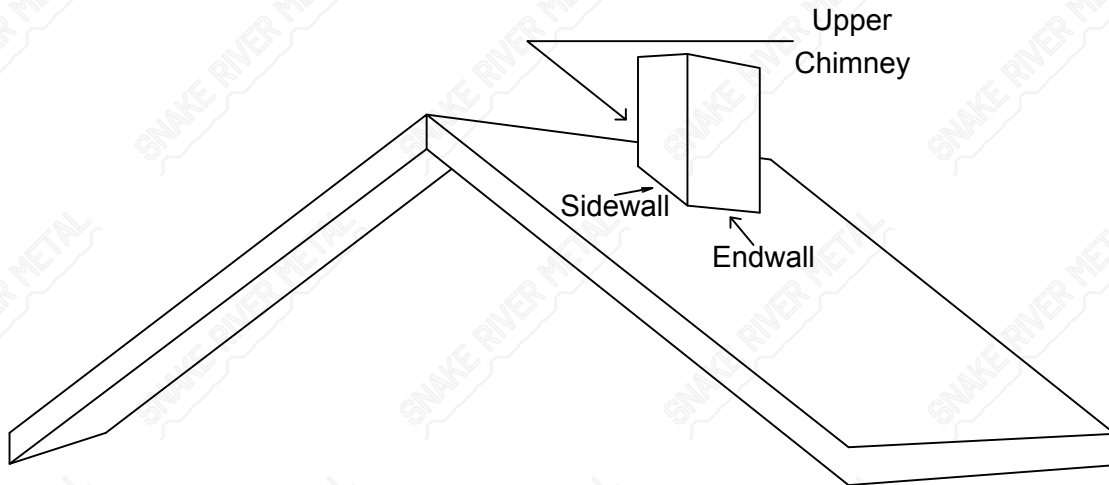

## Most Chimney's Include:

Upper Chimney

Endwall

Sidewall

1 Inside Foam Closure

1 Outside Foam Closure

Upper Chimney On Next Page

Return  
To Top

# Upper Chimney - Spartan

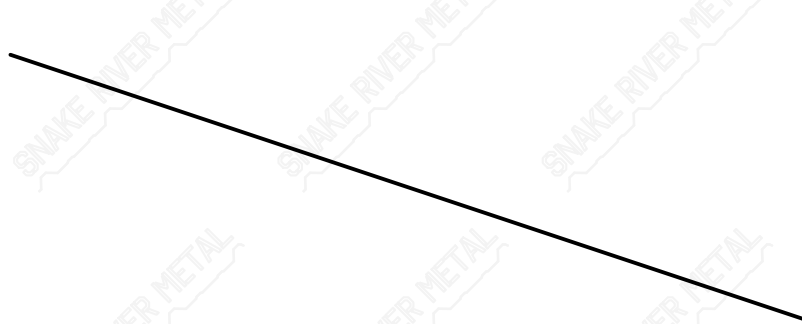

## Upper Chimney

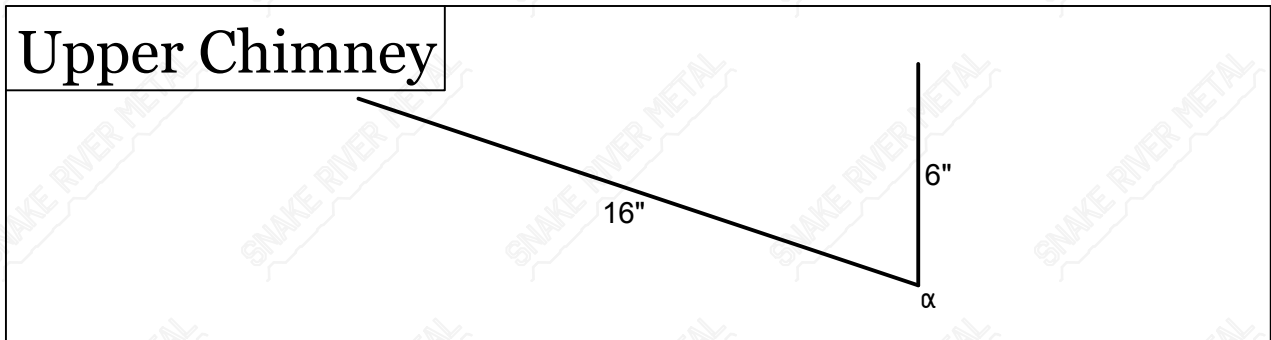

$\alpha$ : Specify Pitch Of Roof

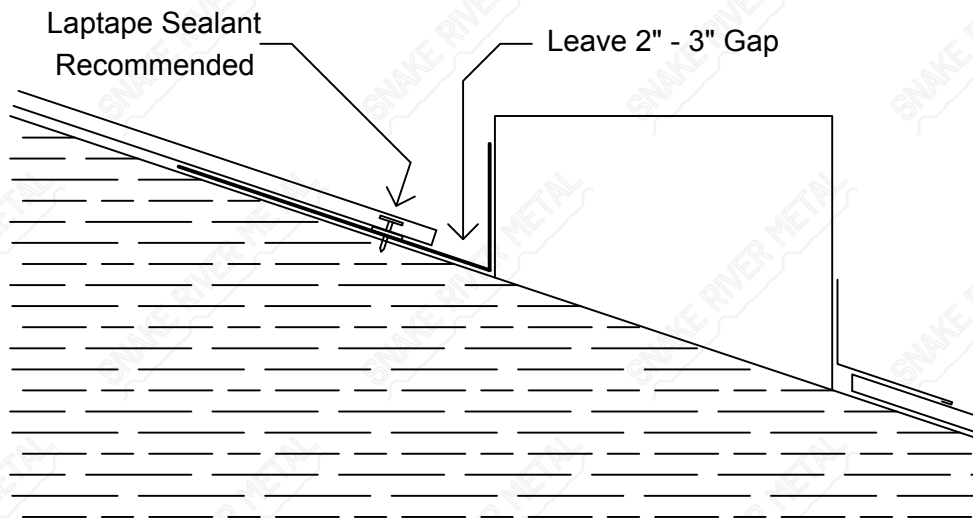

Endwall On Next Page



Return  
To Top

# Endwall - Spartan

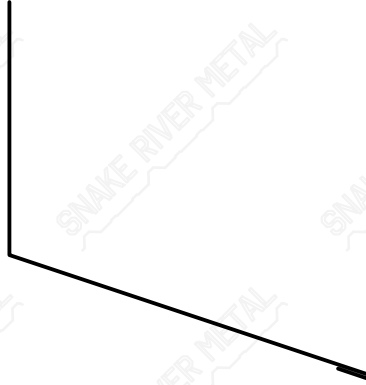

## Endwall

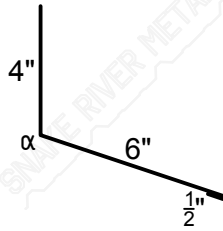

$\alpha$ : Specify Pitch Of Roof

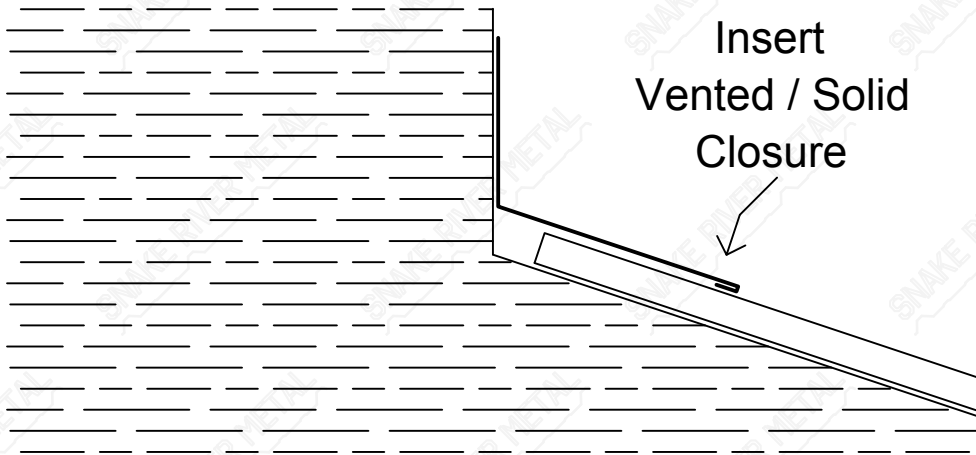

Sidewall On Next Page

Return  
To Top

# Sidewall - Spartan

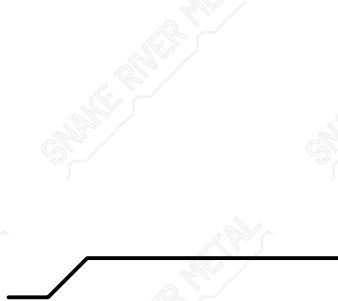

## Sidewall

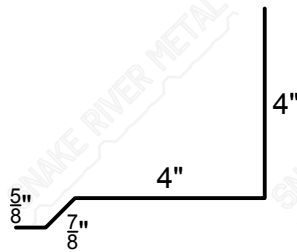

Laptape Sealant  
Recommended

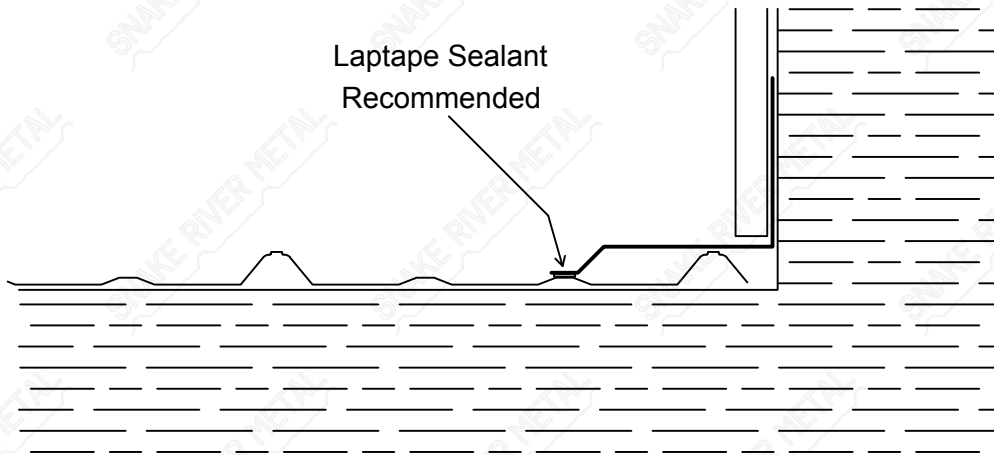

Transition On Next Page

Return  
To Top

# Transition - Spartan

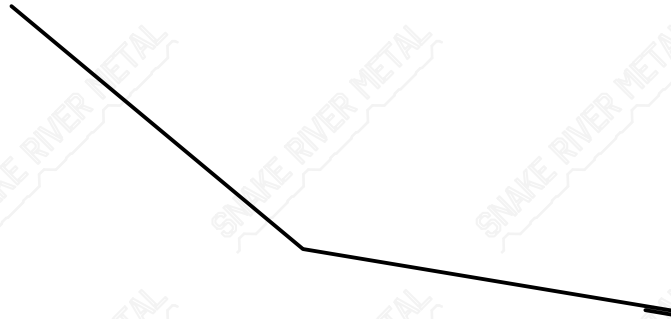

## Transition

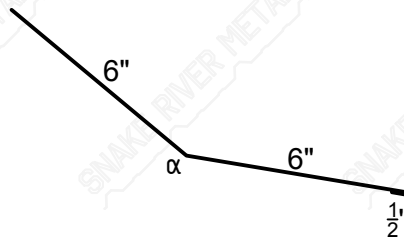

$\alpha$ : Specify Pitch Of Roof

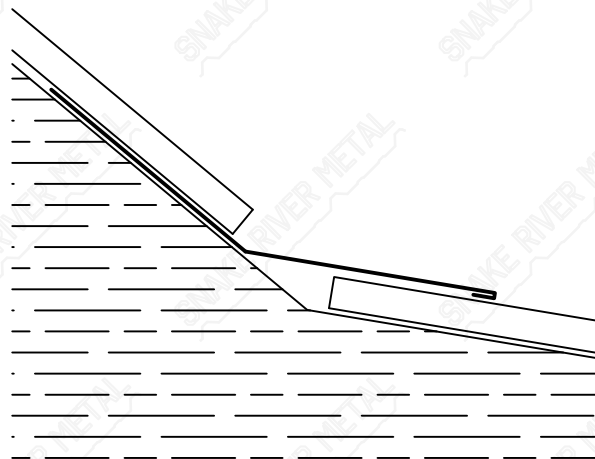

Gambrel On Next Page

Return  
To Top

# Gambrel - Spartan

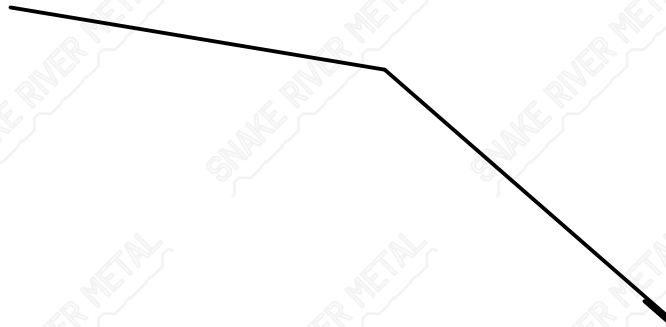

## Gambrel

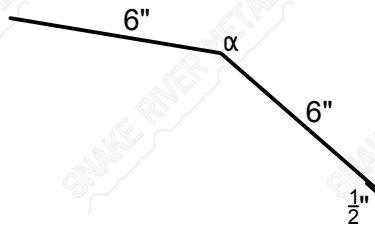

$\alpha$ : Specify Pitch Of Roof

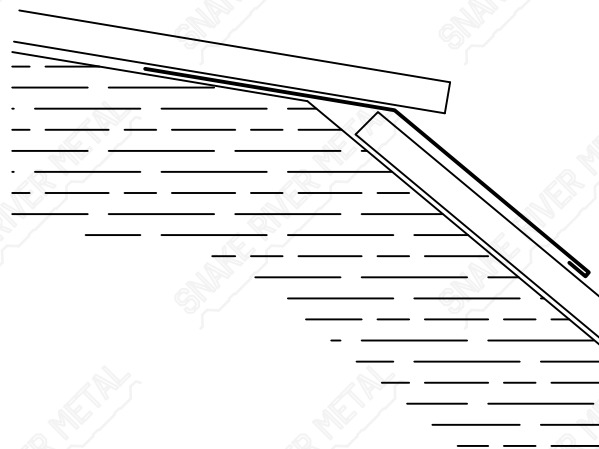

High Eave On Next Page

Return  
To Top

# High Eave - Spartan

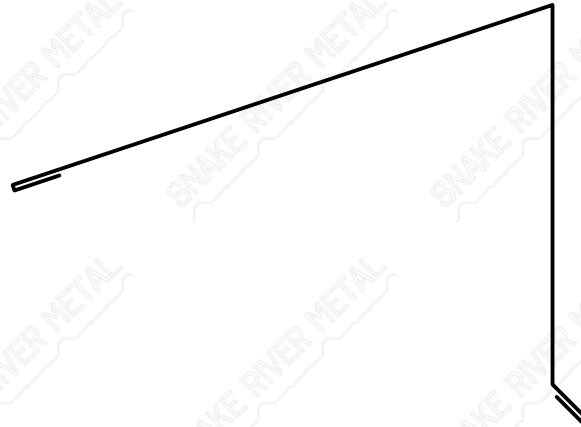

## High Eave

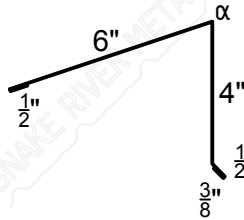

$\alpha$ : Specify Pitch Of Roof

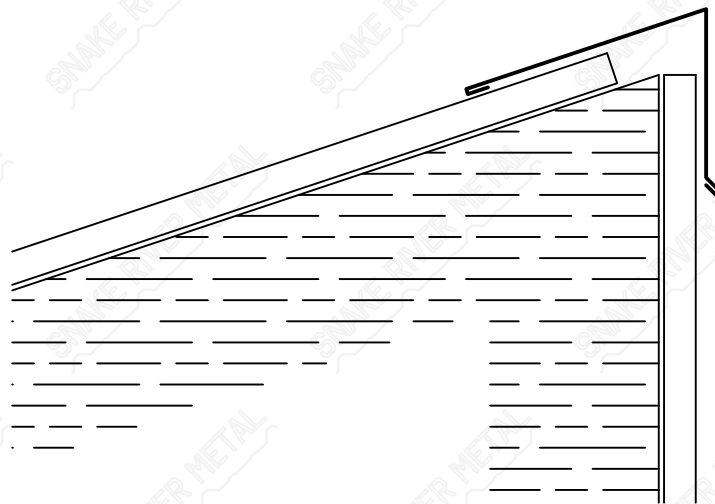

Outside Corner On Next Page

Return  
To Top

# Outside Corner - Spartan

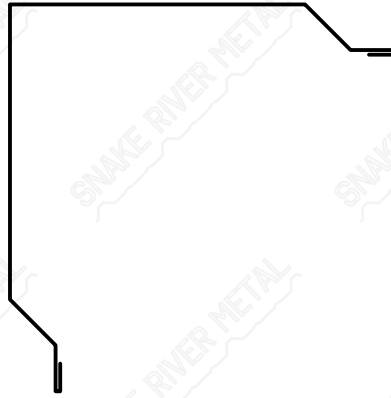

## Outside Corner

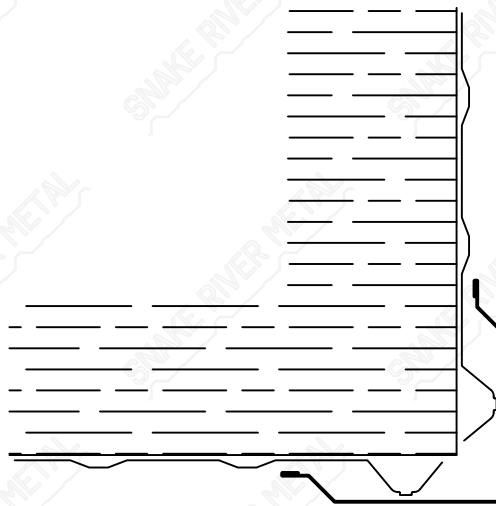
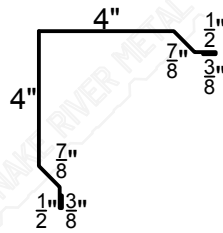

Inside Corner On Next Page

Return  
To Top

# Inside Corner - Spartan

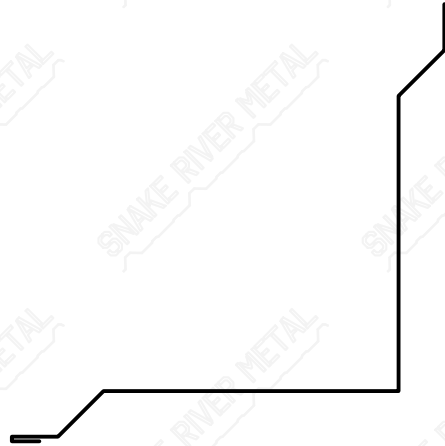

## Inside Corner

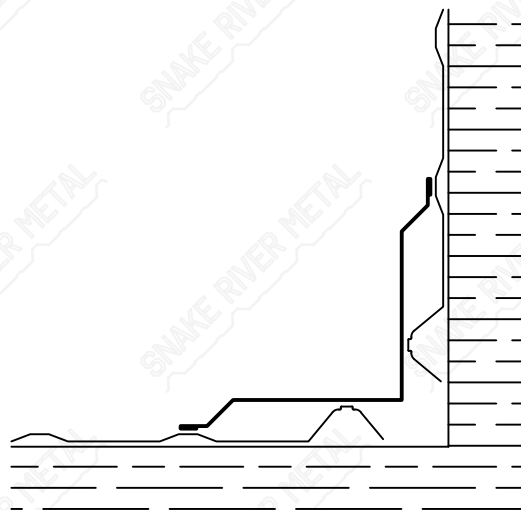
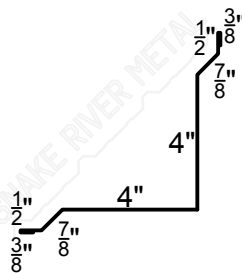

"C" Channel On Next Page

Return  
To Top

# "C" Channel - Spartan

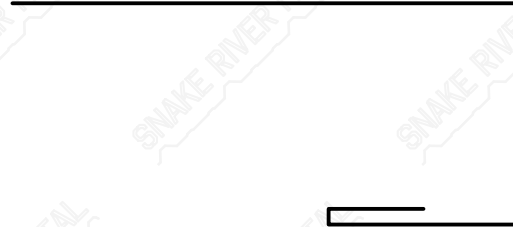

## "C" Channel

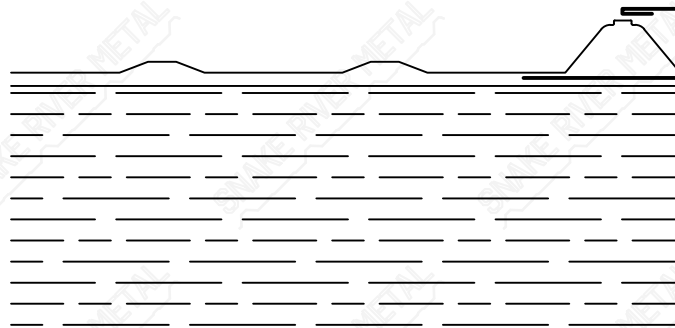
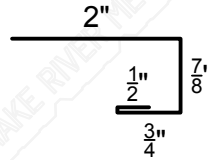

Gutter "C" On Next Page



Return  
To Top

# Gutter "C" - Spartan

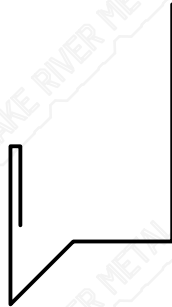

## Gutter "C"

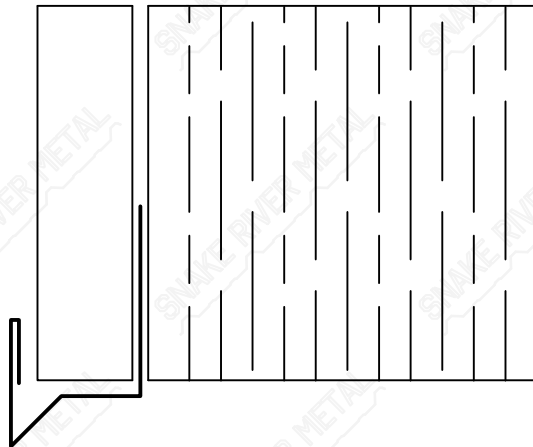
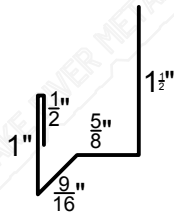

Door Jamb Wrap On Next Page

Return  
To Top

# Door Jamb Wrap - Spartan

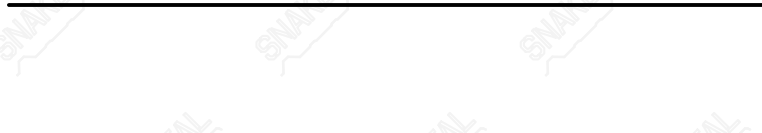

DJW ( 1" x 6" )

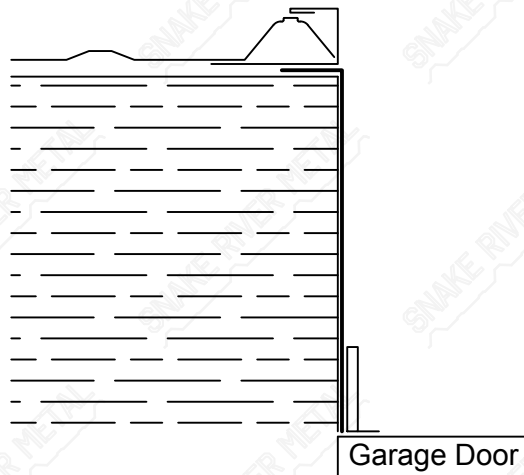

Brick Moulding On Next Page

Return  
To Top

# Brick Moulding - Spartan

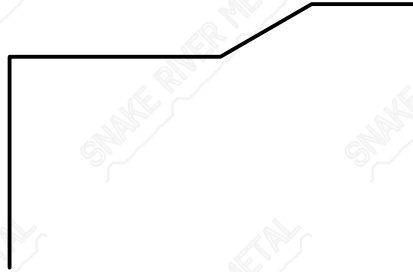

## Brick Moulding

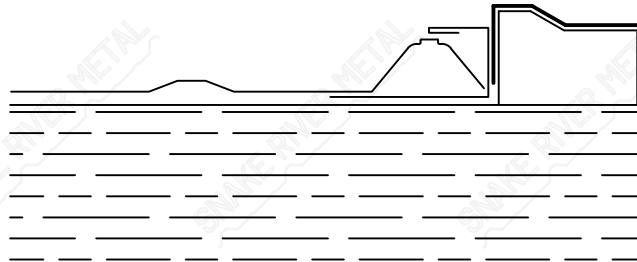
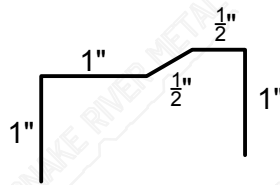

Base On Next Page

Return  
To Top

# Base - Spartan



Base

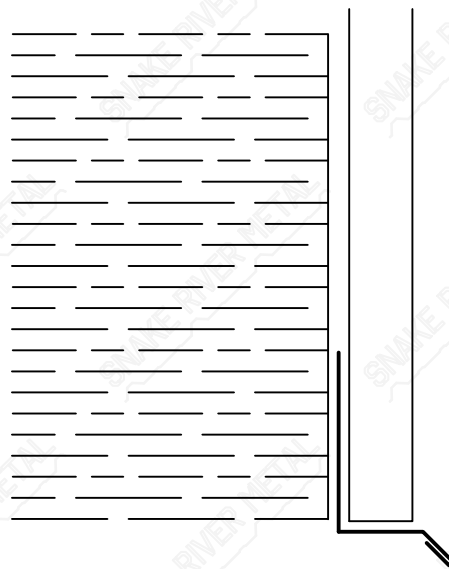
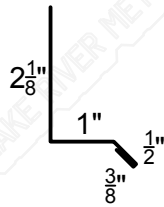

Hugger Base On Next Page

Return  
To Top

# Hugger Base - Spartan



## Hugger Base

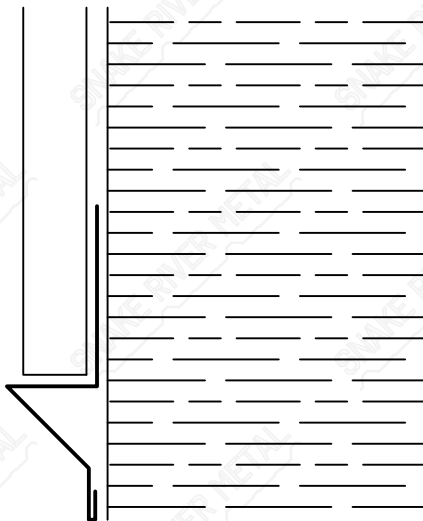
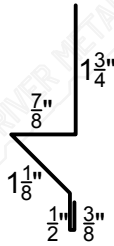

Offset Hugger Base On Next Page

Return  
To Top

# Offset Hugger Base - Spartan

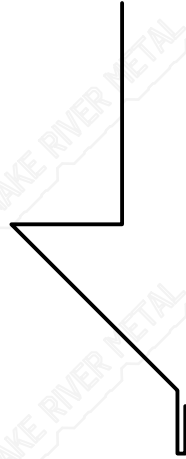

## Offset Hugger Base

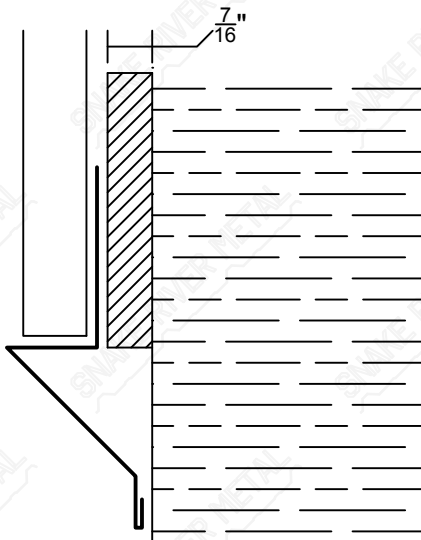
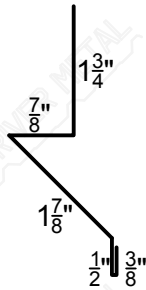

Elevated Wall Base On Next Page

Return  
To Top

# Elevated Wall Base - Spartan



## Elevated Wall Base

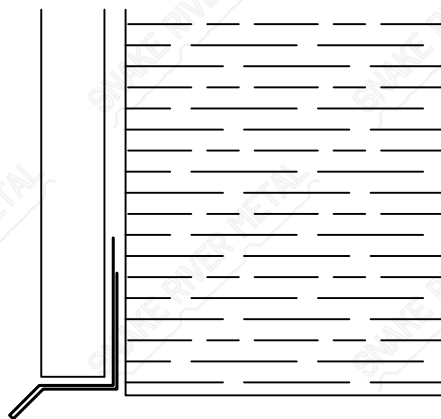
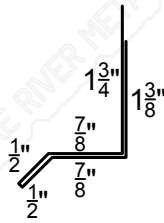

Soffit Wall Base On Next Page

Return  
To Top

# Soffit Wall Base - Spartan

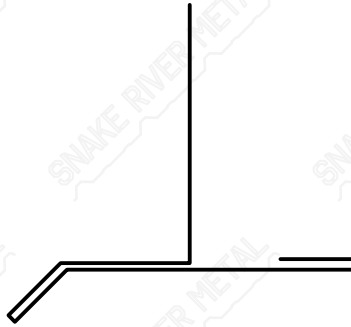

## Soffit Wall Base

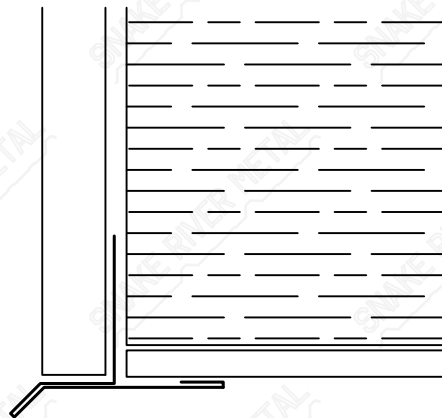
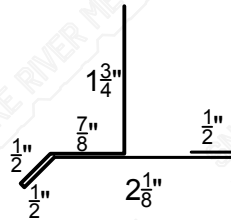

Zee Transition On Next Page



Return  
To Top

# Zee Transition - Spartan



## Zee Transition

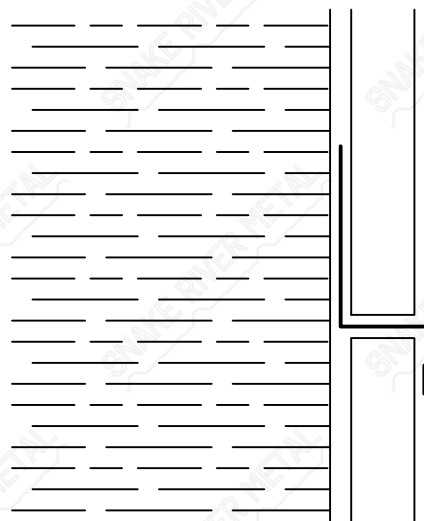
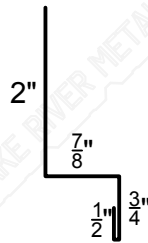

Barn Door Track Cover On Next Page

Return  
To Top

# Barn Door Track Cover

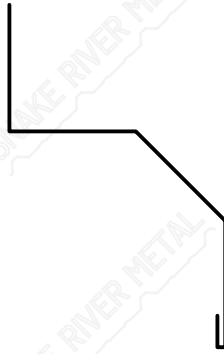

## Track Cover

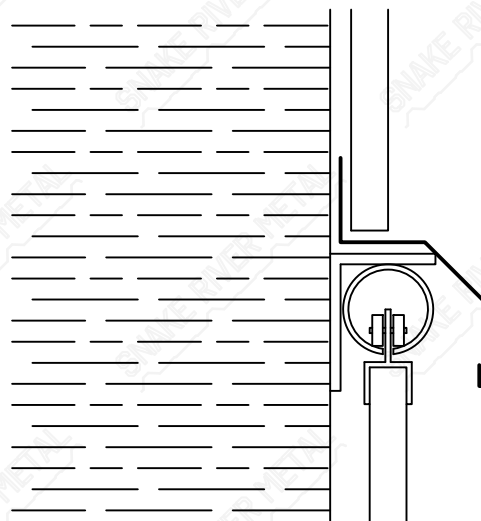
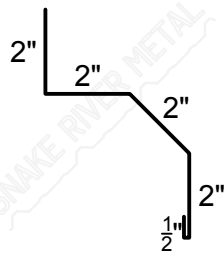

Post Wrap - 1 Piece On Next Page

Return  
To Top

# Post Wrap - 1 Piece

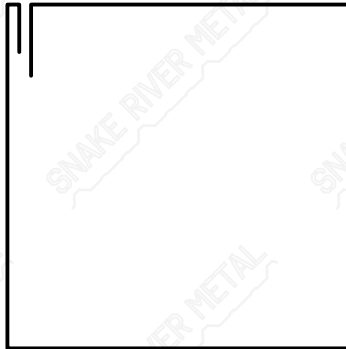

## Post Wrap

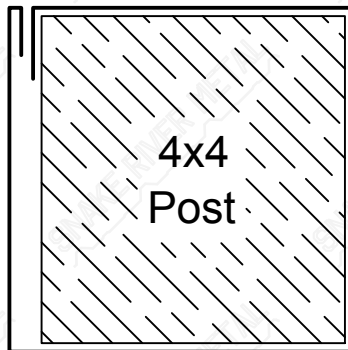
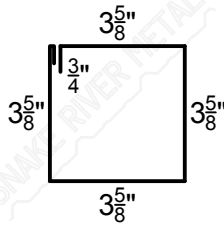

Post Wrap - 2 Piece On Next Page

Return  
To Top

# Post Wrap - 2 Piece

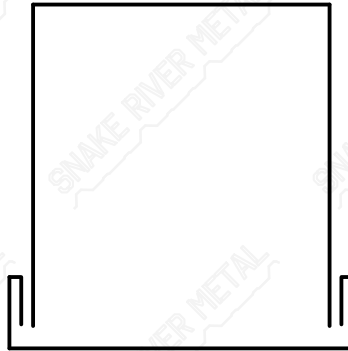

## Post Wrap

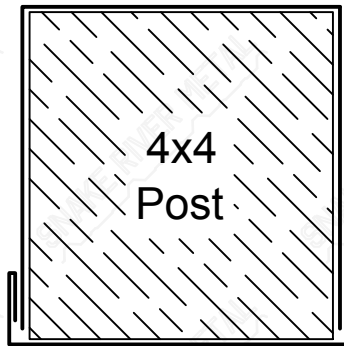
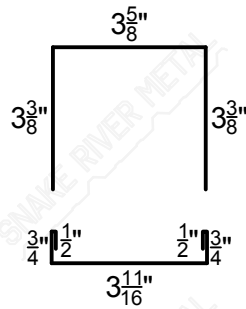

Parapet Cap On Next Page

Return  
To Top

# Parapet Cap

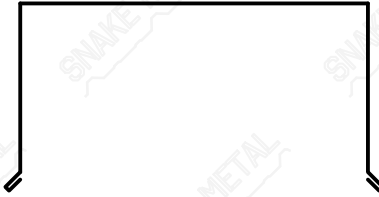

## Parapet Cap

( Specify Dimension )

